



amaziyy

GROUP PROFILE

رؤية VISION



المملكة العربية السعودية
KINGDOM OF SAUDI ARABIA

Our Theme



WHEEL Theme...

...accomplishment at last!

Chairman's Message



We come to work each day for one reason: to make things work for you; not merely on paper, not just conceptually, but practically on the ground, and this is our sheer promise though it's a big challenge!

The diligent commitment of our staff is to gratify our clients by working within their specified time and by attaining their ROI!!

Our Board Team Members



Our Senior Management Team Reporting to Board Members



Our Middle-Management Team Reporting to Senior Management



Our Global Offices



● Very Soon

About Us



Welcome to AMAZIY Group of Companies.

We would like to introduce ourselves as **AMAZIY GROUP OF COMPANIES (AGOC)** as one of the most Reliable and Principal Trading Conglomerates headquartered in Jeddah, Kingdom of Saudi Arabia; having legally established our Sister Companies within KSA, GCC, Asian, EU & NA Regions to diligently provide FMCG Food & FMCG Non-Food Products of Local & International Brands/Origins in enormous quantities to our Esteemed Multinational Clients Globally in parallel to Electro-Mechanical and Construction Services/Maintenance!

We are specialized in Export & Distribution of Agricultural, Petroleum, Meat, Cosmetics, Solar Products/Bi-Products in addition to all types of Logistics & Transportation services, and Electro-Mechanical & Construction Services/Maintenance under one roof due to the fact that we are into Strategic Partnership with renowned Global Suppliers of International Repute! We also own Marketing & Research Agency called MEDIA WIZ having more than 30+ Offices Worldwide!

With abundant experience in the mentioned industries, we have honed our expertise and developed strong reputable producers, ensuring a steady and consistent supply of top-grade of Agricultural, Meat, Cosmetics, Petroleum, Solar, Gold, Logistics & Transportation, Electro-Mechanical & Construction Services/Maintenance, and Marketing & Research to relate our sheer dedication into excellence hence extending beyond just providing the products, while meticulously striving to understand unique requirements of our each & every client and tailor our services to meet their specific needs!

Our enthusiastic teams of professionals are driven by a passion for customer satisfaction and we go the extra mile to ensure seamless transactions with on-time deliveries ensuring competitive pricing in parallel! Irrespective of a large-scale operation or a small business entity, we cater clients of all sizes with equal dedication, loyalty and respect as we firmly believe that our success is knotted with the success of our clients!! Therefore, we place our highest emphasis on building long-lasting relationships based on trust, transparency and reliability!

We look forward to partnering with you and delivering our exceptional on-time services to steer positively your growth and prosperity. So, together, let's build a better future.

AMAZIY Group of Companies... Your Trusted Source for Conscientiousness and Integrity!



Our Attributes

Vision

To be recognized as a Company and Business Partner of choice for delivering on our promises, pioneering new opportunities and approaches and bringing value-for-money to our esteemed Clients & Shareholders.

Mission

To achieve & maintain long-lasting business relationships with our esteemed clients.

Values & Goals

THE TRUST EARNED

Trust isn't given; it's earned. By consistently delivering on our promises, whether to our colleagues, partners or shareholders, we build successful relationships that are built on accountability and mutual respect. This is essential to our long-term success.

OUR DRIVE TO SUCCEED

Our passion for what we do comes through in every area of our business. We are confident, committed and open minded, which enables us to pioneer new and better solutions and approaches, whether analyzing data or at the negotiating table.

PUTTING THE COMPANY FIRST

We know we can achieve far more as a Company than we can as individuals. Our collegial culture and flat hierarchy means that we consider different points of views and approaches to deliver the best solution for the business. When the business succeeds, we succeed.

ENJOYING THE CHALLENGE

For us, it is fun to always want to be better and this means that trying new Things and always looking for better ways to reach our goals. We are proud of what we do and our integrity in delivering it.

Our Attributes

1. We inspire our clients to be our partners making them intense vs their competitors!
2. We build business relationships that are built on our clients' trusts, & it's their trusts on us that derive revenues for them!
3. We educate our clients that their TAs do not buy their products; but, they do buy their services... you can't sell if you can't tell!
4. With us, we fill all our clients' gaps between them & their consumers!
5. We explain business instead of expressing... that's what our clients like best about us as they find solutions for achieving their kpis!
6. We never loose; either we win or we learn, because, when it comes to media, no one comes our way!

Our Employees.. Our Assets!

1. We have multinational nationalities with expertise in local + regional dialects' & are adept at adapting with clients!
2. Our employees never accept defeat as they work on suggestion scheme & work out only to give the best out of them!
3. Our employees firmly believe that working together with their clients is triumph without taking clients for granted!
4. Our employees see things differently and hence can-do things differently for their clients ensuring them that are in safe hands!
5. Our employees put enthusiasm into their work to prevent worry & fatigue, and, dispel preconceived ideas to learn!
6. We can't have everything in one person; hence, we have multi cultural, multi talented & multi disciplined employees!

Our Group Of Companies



GROUP OF COMPANIES



AMAZIY – TRADING

GCC
ASIA
AFRICA
FAR EAST
UK
USA



AMAZIY – LOGISTICS & TRANSPORTATION

KSA
GCC



AMAZIY – COSMETICS

UK
USA
PAKISTAN



AMAZIY – SOLAR ENERGY & GOLD

GCC
AFRICA



AMAZIY – IT

KSA
UAE
PAKISTAN
INIDA



ENGINEERING

KSA



AMAZIY – MARKETING & RESEARCH

Worldwide



AMAZIY LLC - TRADING

BRAZILIAN SUGAR - ICUMSA 45

Sugar is the generic name for sweet tasting. Sugar is found in the tissues of most plants. Honey and fruits are abundant natural sources of simple sugars. Sucrose is especially concentrated in Sugarcane and Sugar Beet, making them ideal for efficient commercial extraction to make refined sugar.

Some certain widely known types are ICUMSA 35, ICUMSA 45, ICUMSA 150, ICUMSA 600-1200, S30, S31, M30, M31, 1701 & 1704.

Notes:

1. We can provide more than 10 Types of Fine & Coarse Sugar from Brazil, Pakistan, India from other Non-Sanctioned Countries.
2. Nutritional Facts can be provided upon request.
3. Detailed specifications of all types of Sugars can be provided upon request.



RICE

There are many varieties of Rice such as Basmati 1121 Sella (White, Golden, Steam & Raw), Basmati 1141 Sella (White, Golden, Steam & Raw), Basmati 1509 (White, Golden & Steam), Sugandha (Creamy, Golden, Steam & White), Sharbati, Sona Masuri, IR6 Parboiled, PR 14/11 (Creamy & Golden), Pusa (Creamy & Golden), and 1718 Golden.

Rice is a Cereal Grain and in its domesticated form is the staple food of over half of the world's population, particularly in Asian & African continents. Rice has become commonplace in many cultures worldwide; in 2021, 787 million tons were produced, placing it fourth after Sugarcane, Maize and Wheat. Only some 8% of Rice is traded internationally. China, India and Indonesia are the largest consumers of Rice.

Notes:

1. We can provide more than 20 Types of Non-Broken & Broken Rice from different India & Pakistan.
2. Nutritional Facts can be provided upon request.
3. Detailed specifications of all types of Rice can be provided upon request.



WHEAT

There are six different types of Wheats such as Hard Red Winter, Hard Red Spring, Soft Red Winter, Durum, Hard White and Soft White.

Wheat is an important source of Carbohydrates. Globally, it is the leading source of vegetable Proteins in human food, having a protein content of about 13%, which is relatively high compared to other major cereals but relatively low in Protein quality but by supplying essential Amino Acids.. When eaten as the Whole Grain, Wheat, is a very good source of multiple nutrients and Dietary Fiber.

Notes:

1. We can provide more than 15 Types of Non-Broken & Broken Wheat from top Grade-A Agricultural Fields from Canada, Australia, US from other Non-Sanctioned Countries.
2. Nutritional Facts can be provided upon request.
3. Detailed specifications of all types of Wheats can be provided upon request.



LENTILS

Lentil seeds are used around the world for culinary purposes. In cuisines of the Indian subcontinent, where lentils are a staple. Split lentils are often cooked into a thick curry that is usually eaten with rice or roti. Lentils are commonly used in stews and soups.

There are four main categories of lentils: brown, green, red/yellow and specialty, Brown lentils are the most common variety.

Notes:

1. We can provide ALL Types of Lentils from top agricultural fields from Canada, Australia, Turkey, US & India.
2. Nutritional Facts can be provided upon request.
3. Detailed specifications of all types of Lentils can be provided upon request.



SPICES

Spices are sometimes used in Medicines, Rituals & Cosmetics or in production of Perfumes. They are usually classified into spices, spice seeds, and herbal categories.

Spices can be used in various forms, including fresh, whole, dried, grated, chopped, crushed, ground, or extracted into a tincture. These processes may occur before the spice is sold, during meal preparation in the kitchen, or even at the table when serving a dish,

Notes:

1. We can provide ALL Types of Spices from India, Pakistan, Indonesia & Vietnam.
2. Nutritional Facts can be provided upon request.
3. Detailed specifications of all types of Spices can be provided upon request.



CORN

There are more than 200 different varieties of corn across the world. The plants vary from 40 cm to 6 m in height, and the ears measure 5 to 45 cm in length with different colored kernels (White, Yellow, Red & Black).

Different classes of corn - such as sweet, dent, and flour, are defined by their internal kernel structure and the proportions of soft and hard endosperm, or starch, present. These proportions of starches allow different types of corn to have different culinary properties.

Notes:

1. We can provide varieties of Corn from US, Germany, UK, France from other Non-Sanctioned Countries.
2. Nutritional Facts can be provided upon request.
3. Detailed specifications of Corns can be provided upon request.



BEANS

A Bean is the seed of any plant used as a vegetable for human consumption or animal feed. The seeds are often preserved through drying, but fresh beans are also sold. Most beans are traditionally soaked and boiled, but they can be cooked in many different ways including frying and baking, and are used in many traditional dishes throughout the world. The unripe seedpods of some varieties are also eaten whole as Green Beans.

Notes:

1. We can provide varieties of Beans from US, India, Vietnam, Kenya & from other Non-Sanctioned Countries.
2. Nutritional Facts can be provided upon request.
3. Detailed specifications of Beans can be provided upon request.



EDIBLE OILS

Some of the many different kinds of edible vegetable oils include: olive oil, palm oil, soybean oil, canola oil, pumpkin seed oil, corn oil, sunflower oil, safflower oil, peanut oil, grape seed oil, sesame oil, argan oil and rice bran oil. Many other kinds of vegetable oils are also used for cooking.

However, Corn oil, Palm oil, Soybean oil, Sunflower oil, Rapeseed (Canola) oil & Olive oil are among the most consumed edible oils in the world.

Notes:

1. We can provide varieties of Edible Oils from India, Indonesia, Malaysia, Mexico & Argentina.
2. Nutritional Facts can be provided upon request.
3. Detailed specifications of All Types of Edible Oils can be provided upon request.



POWDERED MILK

Powdered milk, also called milk powder, dried milk or dry milk, is a manufactured dairy product made by evaporating milk to dryness. One purpose of drying milk is to preserve it; milk powder has a far longer shelf life than liquid milk and does not need to be refrigerated due to its low moisture content. Another purpose is to reduce its bulk for the economy of transportation. Powdered milk and dairy products include such items as dry whole milk, nonfat (skimmed) dry milk, dry buttermilk, dry whey products and dry dairy blends.



Notes:

1. We can provide varieties of Powdered Milk from US, New Zealand, Germany, France & Australia.
2. Nutritional Facts can be provided upon request.
3. Detailed specifications of Powdered Milk can be provided upon request.

Certificates those are provided along with all Shipping Documents are HALAL Certificate, HACCP Certificate and ISO 9001 Certificate.

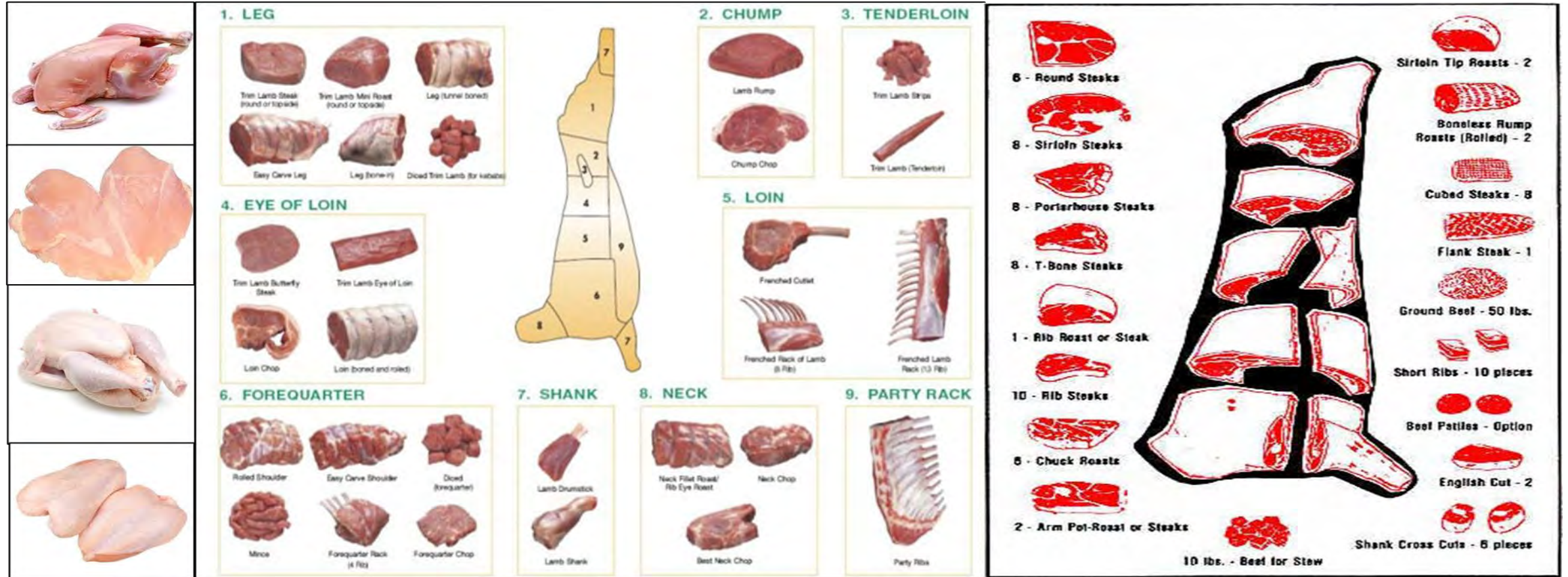

AMAZIY PETRO TRADING LLC SOC - TRADING

PETROLEUM PRODUCTS

Strategic Alliance with well-known Refineries where we are Official Mandates to supply:

KAZAKHSTAN LIGHT CYCLE OIL(LCO)
D2-DIESEL GASL0.2/26GOST 305-82
MAZUT M100 GOST 10585/75
AVIATION KEROSENE COLONIALGRADE A-1
AVIATION KEROSENE COLONIAL GRADE JP54
VIRGIN FUEL OIL D6 ("D6")
REBCO GOST 9965-76 - GOST 51858-2002)
EASTERN SIBERIA-PACIFIC OCEAN (ESPO)
ULTRA LOW SULFUR DIESEL EN590/10PPM
FURNACE OIL CST-FUEL OIL (180,280,380)
GASOLINE ALL GRADES (89-92-93-95)
AUTOMOTIVE GAS OIL (AGO)
BITUMEN ANY GRADE
(LPG LIQUEFIED PETROLEUM GAS (GOST 20448-90)
(LNG LIQUEFIED NATURAL GAS (GOST 5542-87)
MARINE GAS OIL (MGO 500 PPM)
LIGHT DIESEL OIL (LDO)
HIGH FLASH HIGH SPEED DIESEL(HFHSD)
NAPHTHA GENERAL OR HIGH AROMATIC
BASE OIL, SN100, SN150, SN500, N40, N50, N70
PETROLEUM COKE (PET COKE)
GRANULAR AND PRILLED UREA, DAP, NPK, DPK
FETILIZERS



Detailed technical specifications of petroleum products can be provided upon request.

GOLD

Strategic Long-Term Partnership with renowned Gold Mine which is able to do:

- 1. Exploration:** Finding gold deposits using advanced tech (satellite imagery, seismic sensors).
- 2. Development:** Securing capital (investment), planning, and building Mine infrastructure.
- 3. Extraction:** Mining ore through methods like open-pit or underground mining, involving drilling, blasting, crushing, and processing.
- 4. Processing:** Using chemicals (like cyanide) or physical methods to separate gold from the ore.
- 5. Refining:** Producing doré bars (semi-pure gold) to sell to refiners.
- 6. Reclamation:** Restoring the mined land for environmental stability after closure.

According to the supply from our partner, we can do:

- 1. Retail & Wholesale:** Selling gold jewelry, coins, and bullion directly to consumers (souks, online) or to other businesses (jewelers, investors).
- 2. Import/Export:** Facilitating the movement of gold across borders, utilizing UAE's strategic location.



Importing From

X = We Do Not Deal With SANCTIONED COUNTRIES!



Exporting To

X = We Do Not Deal With SANCTIONED COUNTRIES!



AMAZIY SPEEDEX - LOGISTICS & TRANSPORTATION

Comprehensive Logistics &
Supply Chain Solutions!

Delivering
Trust, **On**
Time, Every
Time

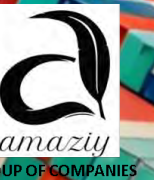

Efficient Logistics. Reliable
Supply Chains.

www.speedex.co

رؤية VISION
2030
المملكة العربية السعودية
KINGDOM OF SAUDI ARABIA

OUR SERVICES AND FLEET

WHAT CAN WE DO Speedex Operates kingdom wide express cargo, FTL, LTL, Lowbed, Special Needs, warehousing and distribution center in all over the kingdom, in addition we provide freight forwarding services (import/export documentation, custom clearance and other such matters) shipping out your overseas facility over the world by using the global network of transport services.

- Inbound Logistics
- Outbound Logistics
- Express Services
- Contract Fleet
- 3PL Logistics Solutions
- F.T.L
- Warehousing Solutions
- Dispatch Services
- L.T.L



INTRODUCTION

A company involved in servicing, maintenance.

Speedex is a service provider focusing on the logistics, services industry and transportations (Domestic & GCC Countries, Freight Forwarder and warehousing, Supply chain management, shifting goods from factories to warehouses and from Sea port and Airport and between distributors. We can represent more than half of your total works. Our global services provide you solutions transport and distribute your goods all over the world regardless of size/weight or destinations.



*15 years of
experience*

SPEEDX

رؤية VISION
2030
المملكة العربية السعودية
KINGDOM OF SAUDI ARABIA

VISION:

To redefine logistics by providing seamless, technology-driven, and customer-focused delivery solutions across the region.



50+ Projects Done!

MISSION:

To deliver goods faster, safer, and more efficiently, ensuring our clients' businesses move forward without delay.



Clients
24

Revenue
10M

Owned Fleet
145

3PL Registered Fleet
300+



global freight forwarding!

OUR SERVICES & *FLEETS*

Nationwide logistics and global freight forwarding.

1 Inbound Logistics

6 Dispatch Services

2 Contract Fleet

7 F.T.L

3 Express Services

8 Warehousing Solutions

4 Outbound Logistics

9 L.T.L

5 3PL Logistics Solutions



SPEED

SPEEDEX GEOGRAPHICAL PRESENCE!



HEAD OFFICE: JEDDAH

AMAZIY

WHY OUR PARTNERS

TRUST US!

- Timely Deliveries
-  SPEEDEX ensures faster transit times and on-time delivery for maximum customer satisfaction.



- Vast Network
- SPEEDEX covers all of KSA and GCC, delivering to 60+

- HSSE Compliance
-  SPEEDEX ensures HSSE with safe, secure, and eco-friendly operations.

- Accurate Invoicing
-  SPEEDEX streamlines billing with accurate, timely invoices — letting you focus on service quality and growth.

FREIGHT



GROUP OF COMPANIES

Experience rapid transit times and meet tight deadlines with our expedited air freight services.



رؤية VISION
2030
المملكة العربية السعودية
KINGDOM OF SAUDI ARABIA

AIR FREIGHT!

Services:

1. Domestic & International Air Shipping
2. Specialized Aircraft Charter
3. Export & Import Shipments
4. Express & Economical Consolidated Shipping
5. Airline Container Handling
6. Scheduled Cargo Arrivals & Departures
7. Temperature- Controlled Freight
8. 24/ 7 Customer Support & Shipment Tracking



R
E
G
I
S
T

**Ensure full compliance
with all international trade
laws and regulations,
reducing the risk of penalties**

LAND FREIGHT!

Services:

1. GPS Tracking & Real-Time Cargo Updates
2. Professional Service at Competitive Rates
3. Comprehensive Insurance for High-Value Loads
4. Multi-Temperature Controlled Transport
5. Expedited Team Service for Critical Freight
6. Cross-Border Global Logistics
7. Emergency & Mission-Critical Transport
8. Complete Route & Freight Management



SEA FREIGHT

Reach major
ports worldwide,
facilitating smooth
international trade
and logistics.

SEA FREIGHT!

Services:

1. Container Terminal Handling
2. FCL & LCL Shipments
3. Breakbulk & Roll- On/R oll- Off Cargo
4. Full & Part Charters
5. Cross Trade Solutions
6. Flexible Delivery Options
7. Reliable Sailing Schedules
8. Customs Clearance
9. Bulk Commodity Shipment Charters
10. Temperature- Controlled Freight
11. 24/ 7 Customer Support
12. Documentation & Cargo Insurance



- WAREHOUSE &
- DISTRIBUTION

Store your goods in our strategically located warehouses, optimizing distribution efficiency

WAREHOUSE SERVICES!

Services:

1. Shared warehousing.
2. Inventory management.
3. Order processing.
4. Cross-docking / transloading.
5. Ecommerce logistics.
6. Receiving of goods.
7. Physical counts and secure storage for improved inventory control.
8. Customization and assembly of product packaging.
9. Pick and pack solutions.
10. Shipments to domestic and international destinations.



CAR RENTAL



150 Toyota Yaris
210 Nissan Sunny

We're offering the latest
models at unbeatable prices!

Cargo Insurance



**Cargo Insurance protects
goods in transit against
loss, theft, or damage!**

CARGO *INSURANCE!*

Services:

1. "All Risk" cargo and marine insurance.
2. Auto transportation cover.
3. Livestock transportation cover.
4. High value goods and fine art transport cover.
5. 3rd party liability coverage.
6. E&O coverage.
7. Professional liability coverage.
8. Professional cargo surveying.
9. Pre shipment inspection



DRIVERS *TRAINING*

- **Focus on Service First Attitude**
- **Experienced Drivers**
- **Contingency Planning**

FLEET *HEALTH*

- **In- house Maintenance Facility**
- **Provision of New Vehicles for Fixed**
- **Contracts**
- **Installation of GPS on All Vehicles**



TRANSPARENCY

- **Monthly Reports: 20 KPI's**
- **Provide GPS Tracking**
- **TRANSPARENCY**
- **GPS Training**

OPEN COMMUNICATION LINES

- **Dedicated Account Manager**
- **Dedicated Supervisor**
- **Prompt Response**
- **24 X 7 Availability**



GPS TRACKING

**Vehicle Tracking GPS / GPRS / GSM services
Round the clock monitoring services with real-
time 24/ 7 support.**

Real-time monitoring alerts.

In case of miss hap urgent assistance.

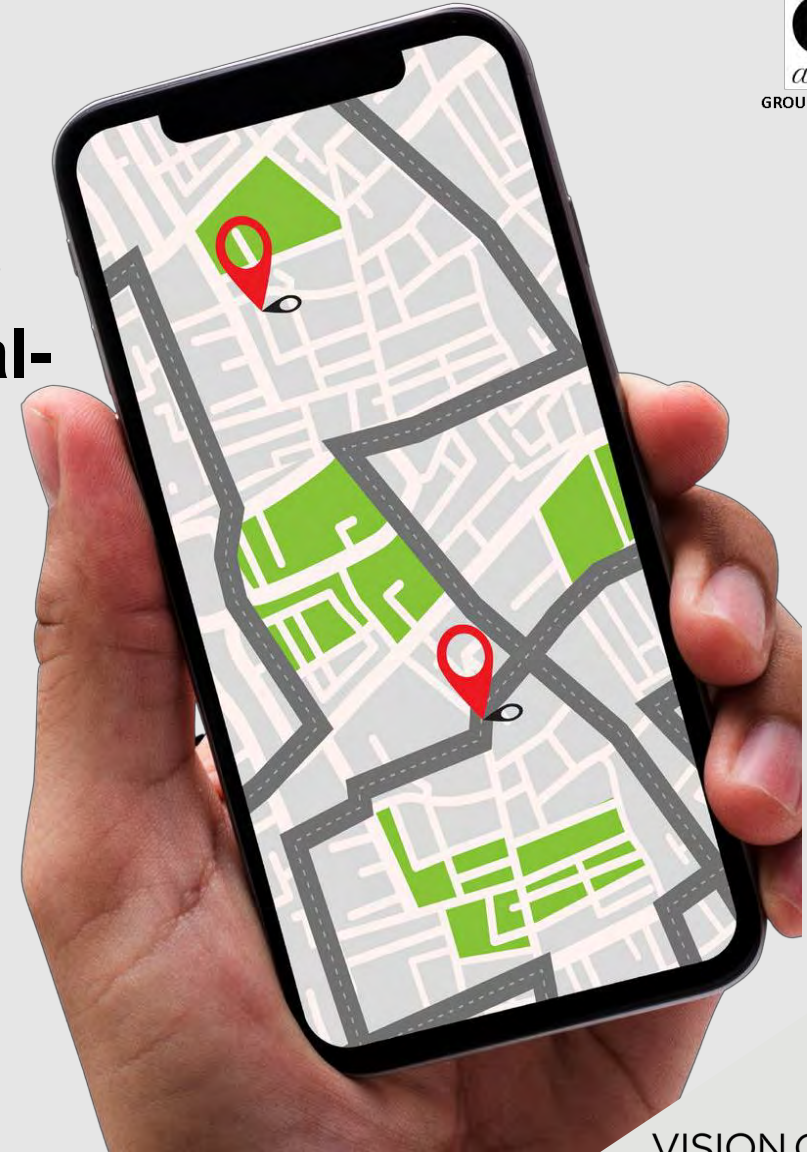

TRADKING SERVICES

- Route
- Driving Behavior
- Attendance
- Schedule Report
- Follow Up
- History



OUR FLEET SIZE

We Serve our valued customers at every project phase, with various attachments detailed below.



Trailer Head Name	Qty
Dyna Dry	40
Dyna Reefer	35
Lorry Dry	20
Lorry Reefer	15
Curtain side	25

Customs Clearance

**Ensure full compliance
with all international trade
laws and regulations,
reducing the risk of penalties**

CUSTOMS CLEARANCE

Services:

1. Automated broker interfacing.
2. Remote location filing.
3. Pre-release of shipments.
4. Customs surety bonds.
5. Duty drawback services.
6. Electronic transfer.
7. Government agency reporting
8. Post-entry services.
9. Tariff Classification Review.
10. Compliance support.



OUR PARTNERS!



كانو للطاقة
KANOO ENERGY
A division of Kanoo Industrial & Energy



سليب هاي
SLEEP HIGH



The Savola Group



مصنع شركة المتولي للمنتجات الفولاذية
Mitwalli Steel Production Factory co.



OUR PARTNERS!



**Comprehensive Logistics &
Supply Chain Solutions**

CONTACT US!

 info@speedex.co

 www.speedex.co

 +966 12 *** ****



**Efficient Logistics. Reliable
Supply Chains.**



رؤية
VISION
2030
المملكة العربية السعودية
KINGDOM OF SAUDI ARABIA

AMAZIY IT

Our IT Company

01

We are focused on Business Solution, Web and Mobile Apps, eLearning Solutions. We have scaled consistently and dependable IT solutions businesses around the Middle East.

02

TAIGER IT is an information technology, We are based in Mumbai India, Jeddah KSA, & Dubai UAE Founded in 2020.

03

TAIGER IT are now organized around two key areas: Professional Services & Consulting and Outsourcing Services.

Our IT Services

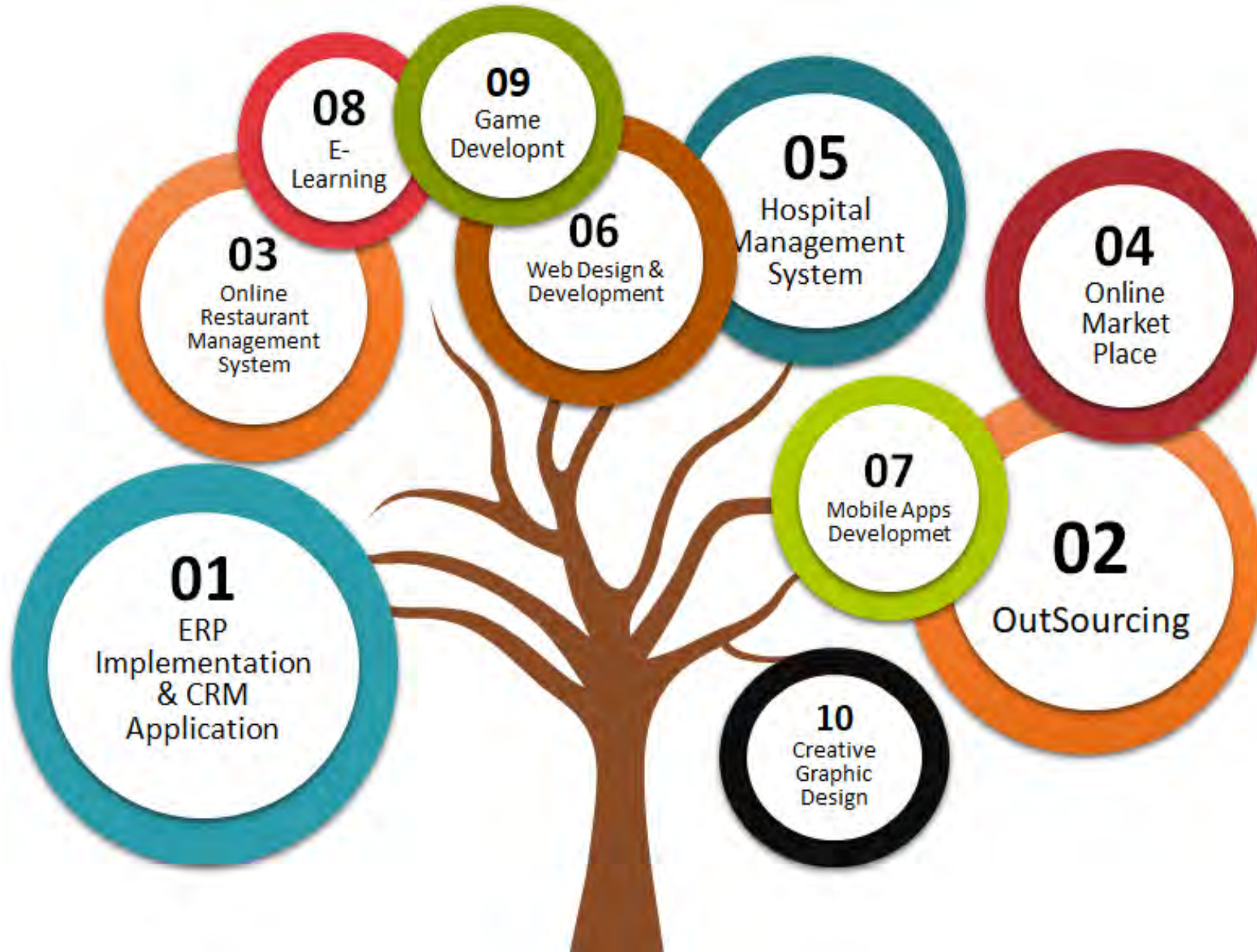

About ERP Oracle/SAP/IFS Implementation and Support

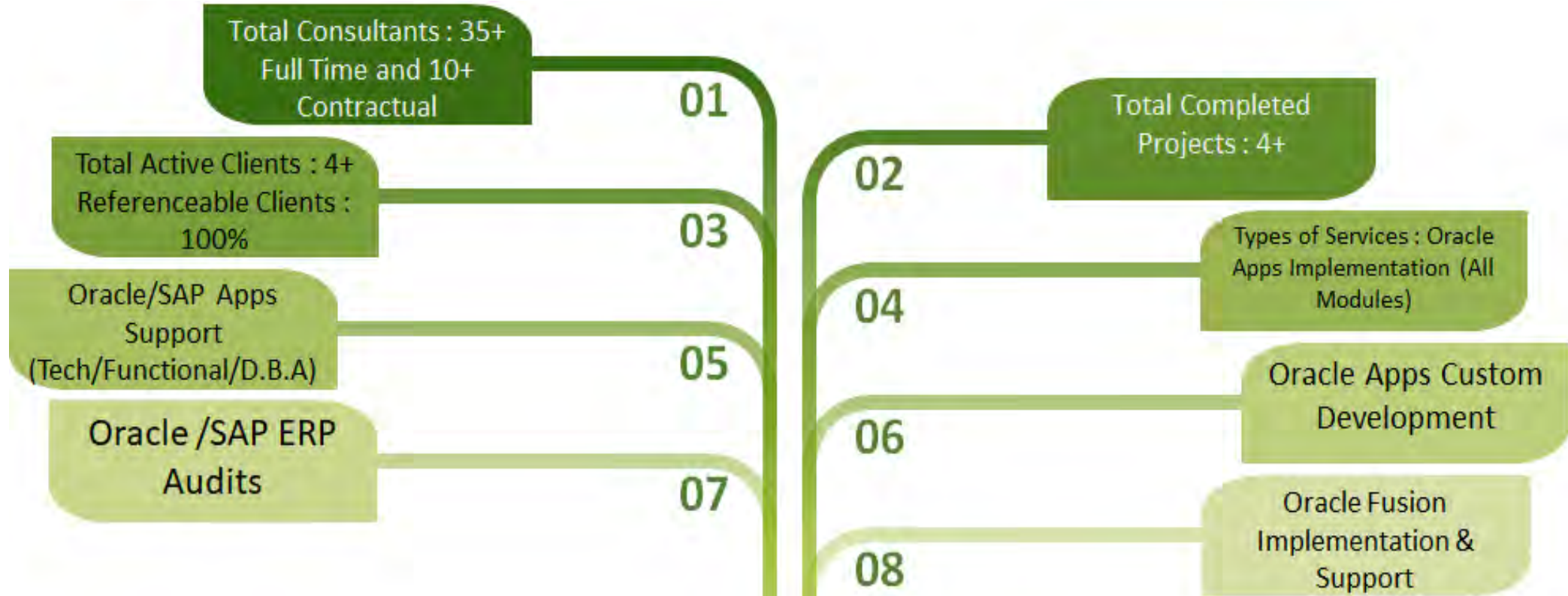

Business Case



- Using 12.1.3 version of EBS on Windows in a single node environment
- Looking to upgrade from 12.1.3 to 12.2.
- Modules used- GL, AP, AR, CM, PO and Inventory

Solution Highlights

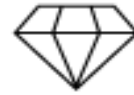

- Successful upgrade from Oracle EBS 12.1.3 to 12.2.7
- Dual node in a RHEL 7.3 environment
- Functionalities beneficial to the client introduced
- ✓ Use of Control accounts extended to Web-ADI.
- ✓ Period closure improvements.
- ✓ PO related search enhancements

Leading FMCG Firm in KSA

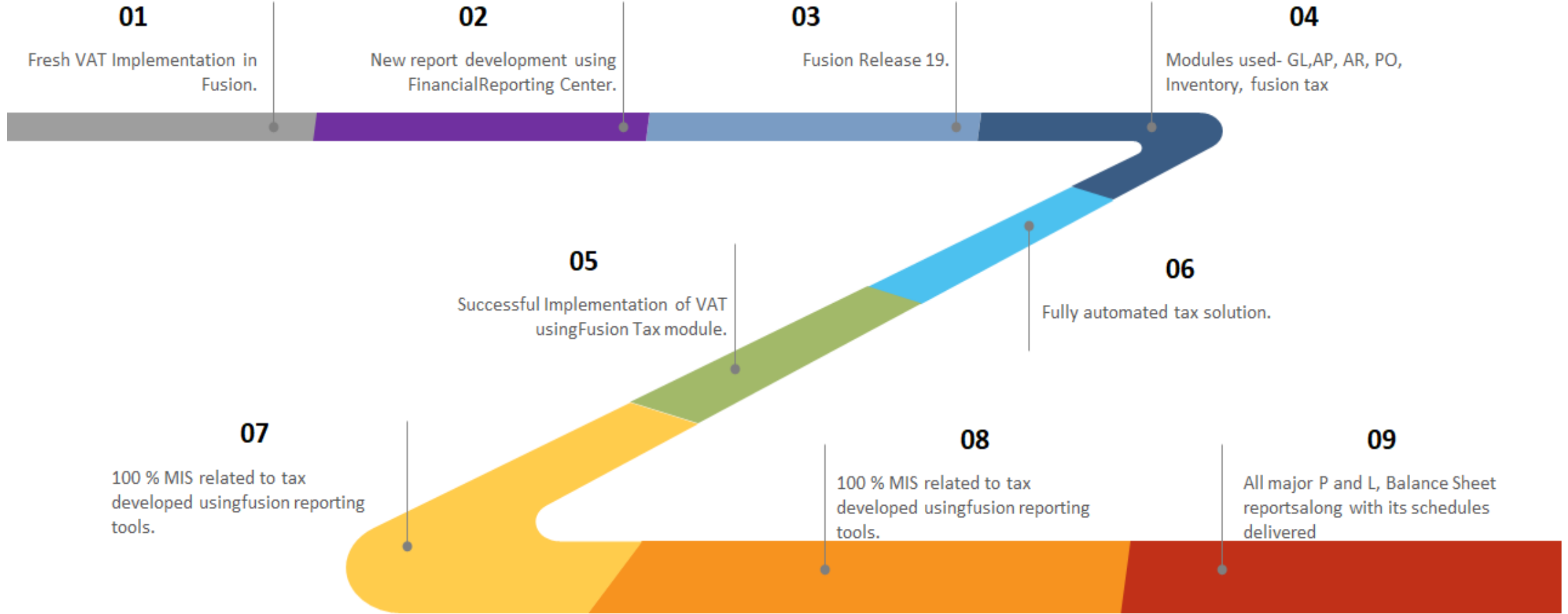

Our IT Clients

- Al Batterjee
- Tawuniya Insurance
- Abha Medical University
- Shifa Medical
- WokToWalk
- Al Rajhi Takaful
- Freshly Frozen Food – UAE
- Bahar Asia – Delivery VAN Sale
- Gawamen – Online Food Delivery App
- AI - POC Project for Loan Rejection Control Engine Projects for Banks in KSA

Hospital Management System

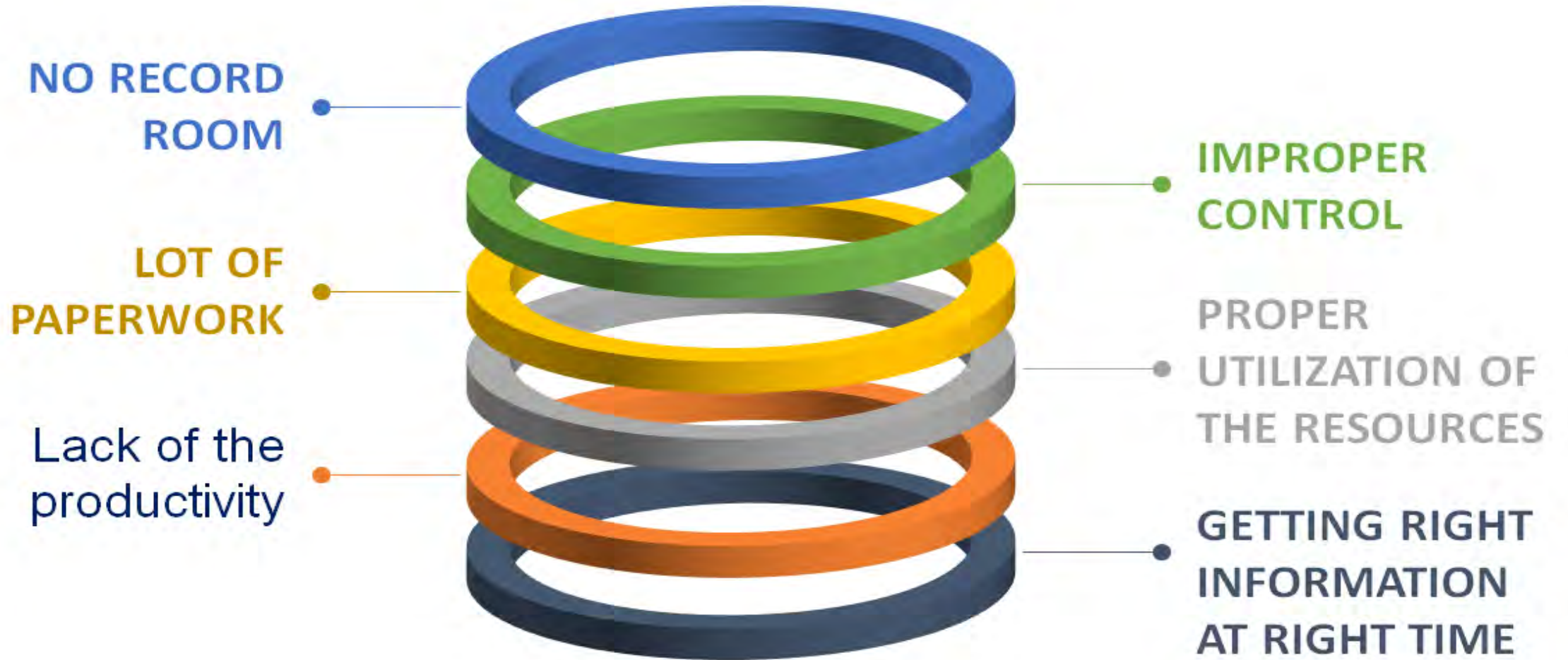

Once we had completed Tazaj and 2-3 More Resturant Implementation we can raise 5-10 Million USD to make it scabbled like Foodic



Powerful POS



Order Process

- » Post-payment and Pre-payment Support

Running Orders

- » Real Time Running Order List
- » Running Order Modification
- » Running Order Cancel
- » KOT Print/Kitchen Update for Only Modified Items

Order Types

- » Dine In, Take Away, Delivery
- » Service/Delivery Charge
- » Delivery Address and checking address for delivery order
- » Table with time tracking for Dine In order

Dental Application

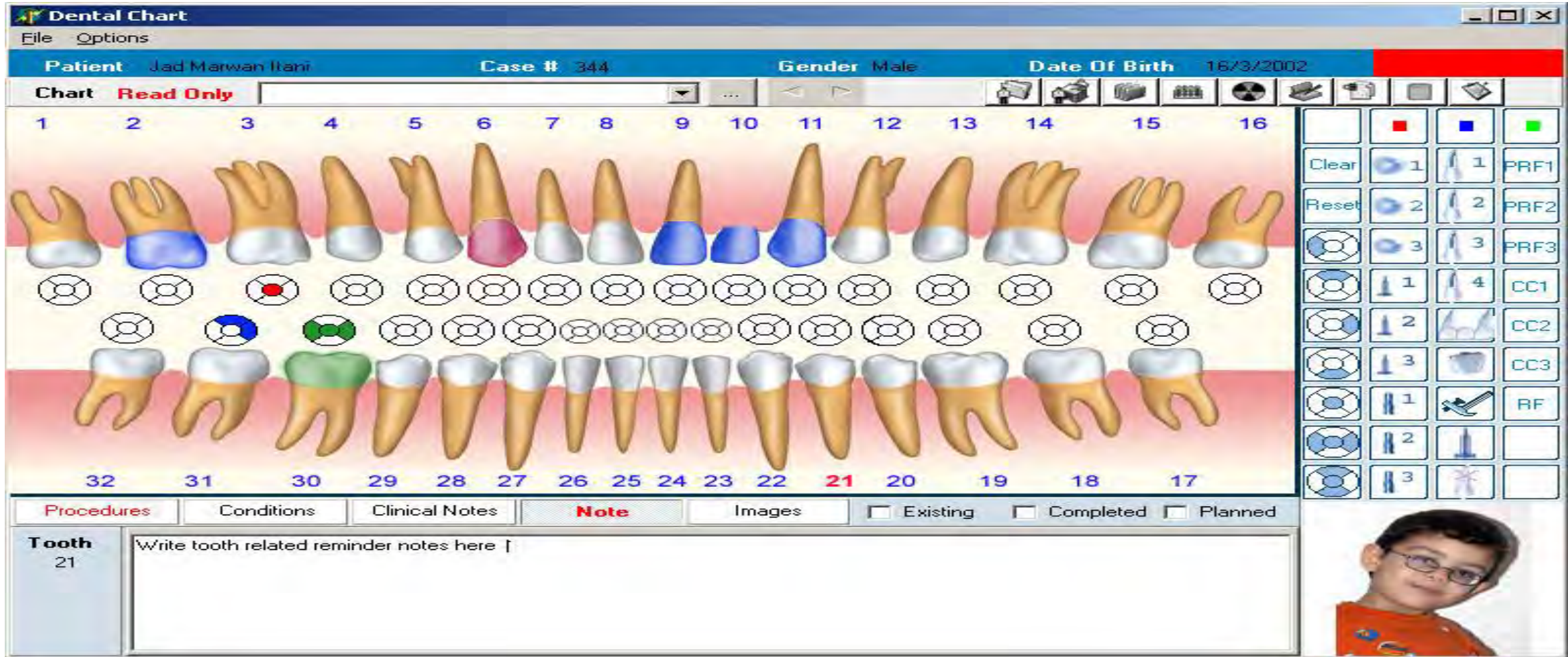

Dental Chart
File Options

Patient: Jad Marwan Itani Case #: 344 Gender: Male Date Of Birth: 16/3/2002

Chart: Read Only

1 2 3 4 5 6 7 8 9 10 11 12 13 14 15 16

32 31 30 29 28 27 26 25 24 23 22 21 20 19 18 17

Procedures Conditions Clinical Notes **Note** Images Existing Completed Planned

Tooth 21
Write tooth related reminder notes here |

Web & Mobile App Solution



Our websites are built on latest technologies like HTML5, CSS3 and use the Bootstrap technology which makes each of them responsive and mobile ready.

01



This has enabled each of these websites to be listed on Google keeping in mind, the SEO parameters set to make the websites mobile friendly and responsive.

03



The websites which Zollal are compatible with all latest browsers and devices and cater to any target audience and mediums.

02



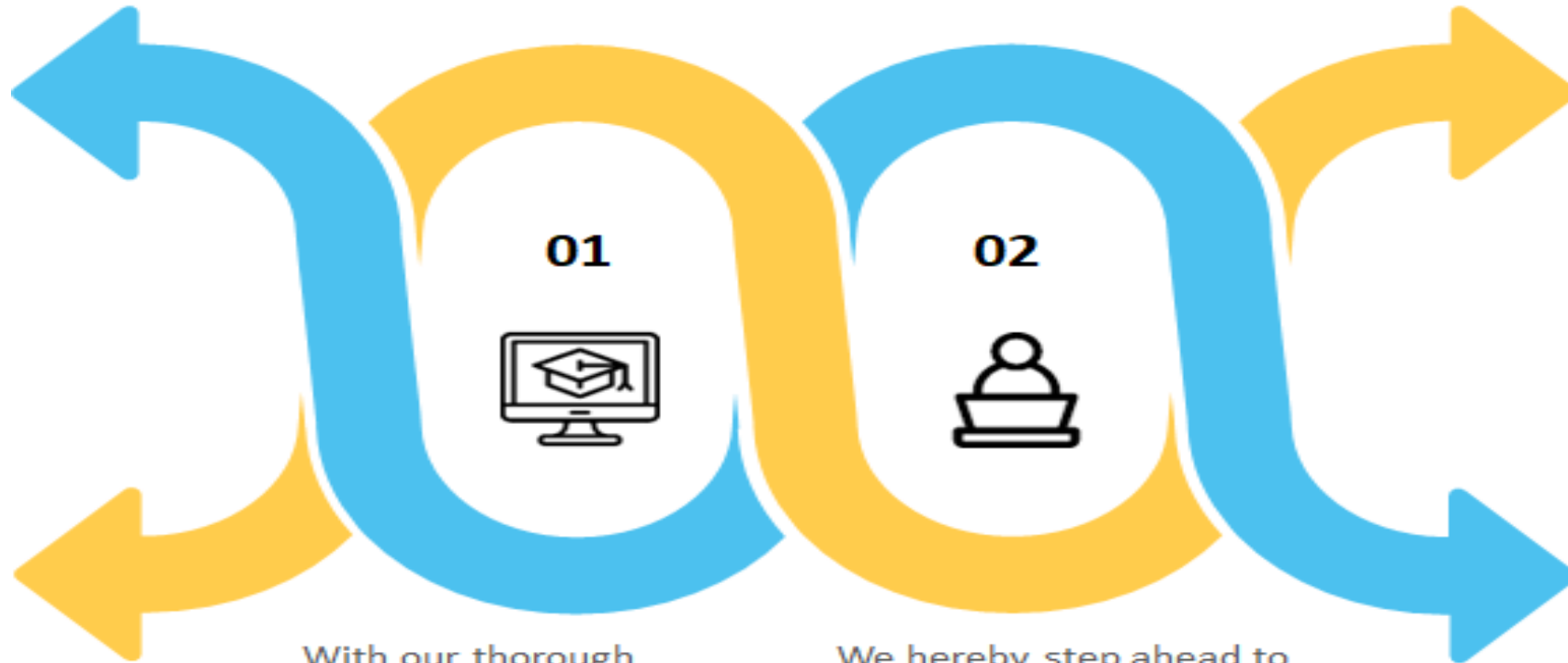

01



With our thorough research and practice, we have achieved delivering remarkable eLearning solutions in the upcoming era of education through technologies.

02



We hereby step ahead to revolutionize the eLearning structure and make it eminent, efficient and convenient. Conceptualize, visualize and execute. With these effective key points, we excel in any venture we embark on.

At Zollal, our team of experienced Digital Marketers has in-depth knowledge about choosing the right campaign and building digital marketing strategies for businesses belonging to different industries.



Digital marketing strategies for businesses belonging to different industries.



01

We develop Stress buster as well as Educational and Arcade games that we believe can deliver strategic solutions.

02

Building brand awareness and advertise products that will lead to a boost in sales. Improve interaction and induce customer involvement so as to create a sense of belonging for them.

03

Create winners and spread happiness.

Outsourcing

01

We are a one stop Staffing solution, if you are looking for



02

A professional company to manage IT Professional, Finance related needs of your outsourced employees.



04

An outsourcing partner which is digitally enabled with the latest automation technology and mobile technology to support volumes of outsourced employees including leaves, attendance, location tracking and much more.



03

Ways to reduce the administrative costs related to managing your outsourced employees.



Technologies we work with Mobile

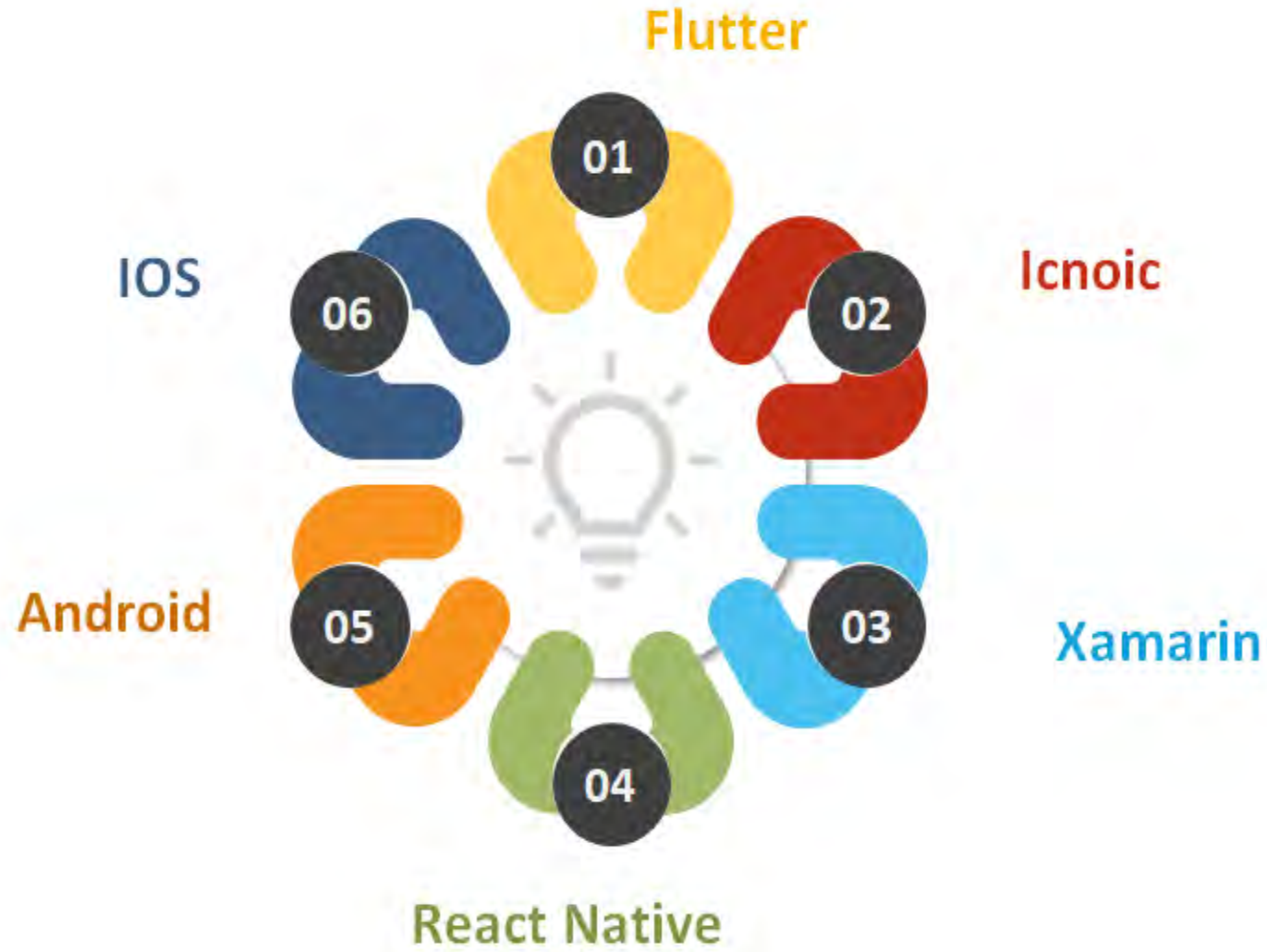

Technologies we work at Backend

Node

Java

PHP

Python

.NET

Rails



Technologies we work at Frontend

Angular

Type script

React JS

WPF

Value

HTML 5



AMAZIY VARCHASVA - SOLAR ENERGY



Wake up to New Dawn

Varchasva is a market leader in solar industry

Varchasva Energy Pvt. Ltd., a world-class EPC and O&M contractor for utility-scale solar power projects is an odyssey into a new dawn. The vision of a first-generation entrepreneur who saw tremendous potential in tapping solar energy to meet the ever-rising demands of an energy-guzzling economy, our brand story is of a lot of drive, determination, hard work and, finally success.

**Going solar saves money,
generates more money & reduce taxes.
Provide a cleaner today and tomorrow.**



varchasva
A GREENER TOMORROW

Why VARCHASVA ?

Varchasva is the leading provider of solar power project development solutions from concept to completion.

Living responsibly - living holistically

We offer energy rich solutions that not only become a way of your life, it enhances your life. Adding meaning to your lives remains our crucial concern at all times. If the way we live attunes with the environment factors and doesn't pose a threat to the natural renewable sources of energy, then it seems a feasible, Holistic and worthwhile option. Conscientious efforts in the field of solar energy consumption has made us what we are today. We owe our existence, success and sustenance to the eco friendly technologies with futuristic solutions. From inception stage to where we stand today, the Company has witnessed a significant graph of growth. It has been a continuous process of learning and putting our best foot forward to bring about the best possible offerings for our esteemed clients.

We have been successful in establishing a firm foothold in the market, making responsible consumers, and green spaces which co exist effectually within the environment sensitive parameters.

We strive for **QUALITY, SERVICE & VALUE FOR MONEY**

Our Solutions/Services

> Rooftop solar PV solutions

A new way of saving power right above your roof, along with storing it for later use.

> Engineering, Procurement & Commissioning

With expertise in solar efficient solutions, blending updated technologies to meet the client's needs; we offer complete solutions from scratch to finish. Creating spaces that breathe life more green, more sustainable, using indigenous resources, we procure power packed options for spaces.

> Operation & Maintenance

remains an important supplement which we make sure we never overlook.

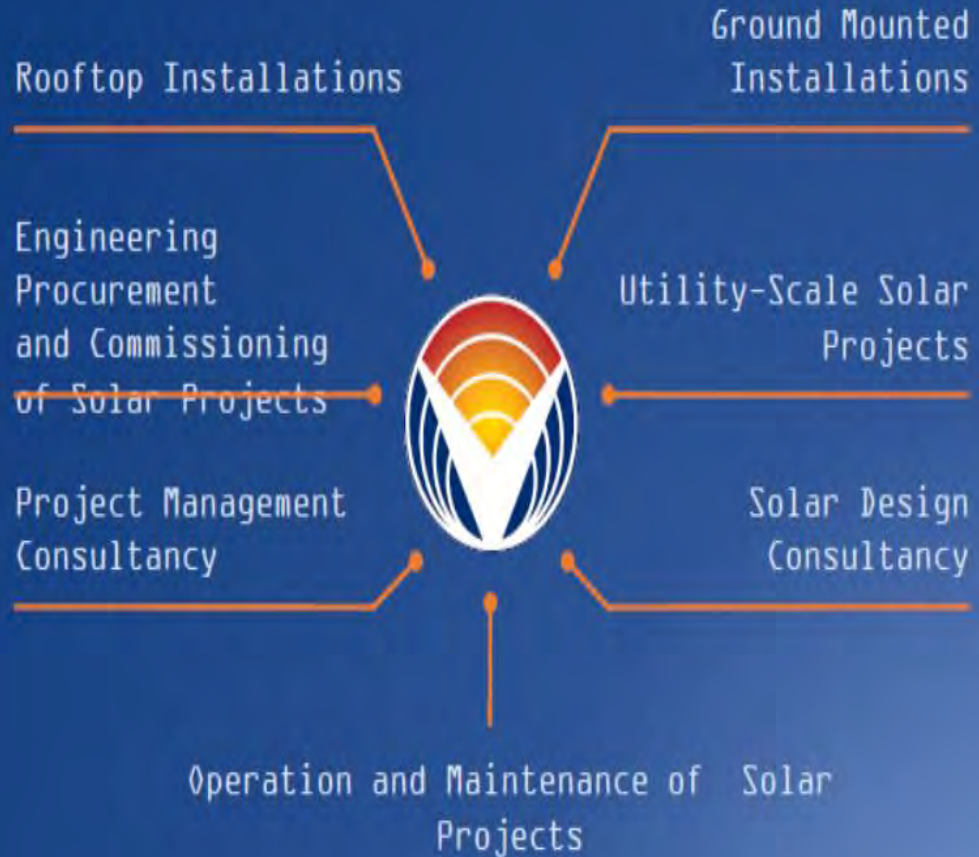

VARCHASVA'S VISION

We want the whole mankind to benefit from the free energy that we receive from the sun. This VISION is reflected in Varchasva's four values:

- ▶ **We are Responsible**
- ▶ **We are Collaborative**
- ▶ **We are experienced**
- ▶ **We are Sustainable**

WHAT DO WE PROVIDE

- EPC for Solar Power Plant
- Solar Rooftop EPC
- O&M for solar power plant & Rooftop Solution

HOW DO WE DO IT

We have the experience and capability to support solar projects from inception, through development and construction during the complete lifetime of the plant. We deliver engineered solar solutions for cement sheets, asbestos sheets, RCC roofs, industrial roofs and ground, maintaining very high standards of quality both in terms of procurement and execution.

Our two most important corporate objectives are to...

- Quickly and sustainably reduce the cost of photovoltaics
- Make solar energy competitive.

In order to achieve these goals, we are committed to...

- Developing all innovative, new technologies that will lead to a significant reduction in energy costs and consumption (LCOE, or Levelised Cost of Electricity) and;
- Expand our EPC business (engineering, procurement and construction) besides looking for opportunities in project development based on our strong credibility in the solar market

SOLAR ENERGY SIMPLIFIED



Our solar solutions are intrinsically simple and carefully-designed to world's top engineering standards. We are committed to minimize your carbon imprint by helping you generate energy from solar sources with optimum outputs to guarantee you the best value for your money. Besides, we believe in quality and don't ever deviate from it.

We undertake turnkey projects – from installation to maintenance, to make your journey towards sustainability completely trouble-free. We have strong laid down legal and financial closure and commissioning processes to smoothen your transition to green energy. Give us your unused roof or a defunct parcel of a land site, and our engineers will work out the most efficient package for your journey into the clean future and provide you maximize your return on the investment in the shortest possible timeframe

Benefits of SOLAR ENERGY ?



It provides improvement in air quality and public health



It reduces dependence on traditional source of energy



It helps to reduce greenhouse emissions

Benefits of SOLAR ENERGY ?



It protects against rising energy costs



It helps you earn a great return on your investments



As per schedule VII, companies may include it in their CSR policies

REASONS TO GO SOLAR

Reduce Electricity Bills: If you currently pay a monthly bill of Rs. 1000/-, then you can save over 4 lacs over lifetime by going solar.

- Locked in Electricity Tariffs, Reliable, Proven Technology
- Electricity prices are increasing 5% per year.
- Installing a solar system insures that the tariff hikes have zero effect on your wallet.
- Most of our solar systems are 24 years of generation warranty.

HOW DOES IT WORKS ?

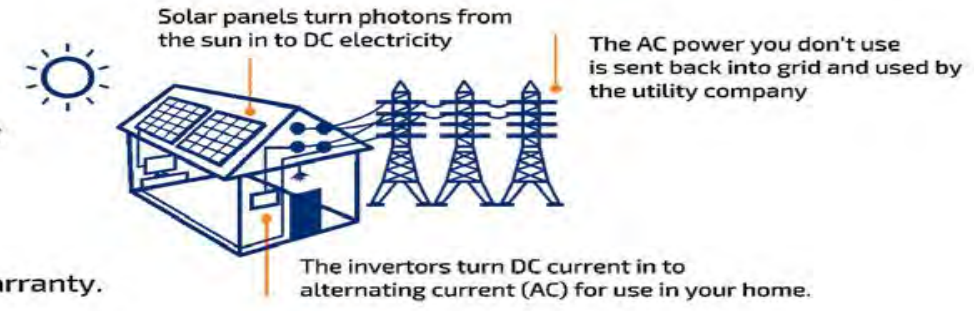

CONTROL YOUR ELECTRICITY EXPENDITURE WITH SOLAR!



₹ 14 - 18
\$ 0.18 - \$0.23

You pay for Diesel Generator



₹ 7 - 11
\$ 0.094 - \$0.098

You pay for from the Grid 3-8 Per Year



3 - 8 %
3% - 8%

al rise i
iesel prices

Your electricity expenditure will not reduce in future. It will rise more and more. So if you want to reduce your electricity bills and save money spent on diesel generators, then you should install solar.



SOLAR IS NOT COSTLY



Cost of
100KW

this might sound as a lot of money

USD 120,000/-



UNITS OF ELECTRICITY
GENERATED ANNUALLY

1,50,000

\$ 1,50,000/-

Will depreciate by 1% annually

EQUITY

₹ 12,50,000/-

\$ 36,000/-

30%

DEBT

₹ 71,50,000/-

\$ 84,000/-

Remaining 70%

Repayment Period

4 Years

5 YEARS

Interest Rate

0.30%

9.30%

VARCHASVA'S VISION

We want the whole mankind to benefit from the free energy that we receive from the sun. This VISION is reflected in Varchasva's four values:

- ▶ **We are Responsible**
- ▶ **We are Collaborative**
- ▶ **We are experienced**
- ▶ **We are Sustainable**

WHAT DO WE PROVIDE

- EPC for Solar Power Plant
- Solar Rooftop EPC
- O&M for solar power plant & Rooftop Solution

Pre Installation

- **Agreement:** A comprehensive agreement after initial inspection
- **Site Audit:** After an inspection and noting the particularities of your rooftop, our team proposes a design layout
- **System Design:** Solar Panels layout based on structural calculations & other important measures for a working system.
- **Installation:** Our team starts the installation. We usually finish the installation under 15 days.

Post Installation

- **Permissions & Approvals:** Upon the installation of the power plant, we commission it by taking relevant approvals
- **Utility Interconnection:** Permission to operate with the local DISCOM authority and be able to exchange energy from grid
- **Sale of Electricity:** Selling the electricity credits and route collections to you on monthly basis.
- **O&M:** Comprehensive operation and maintenance for the entire life cycle of plant with limited warranties.
- **Monitoring & Operation:** 24 Hrs system monitoring to stay alert about the system production, failures and plant health.

Our PROJECT METHODOLOGY

Synchronisation of able minds and apt methodology puts us at an edge above other market competitors. Beginning from accurate planning to actual implementation, each step in progress

is assessed and activated with utmost precision and systematic functioning from conceptualization to completion. Deriving maximum benefits

for our clients remains our top most priority at all times.

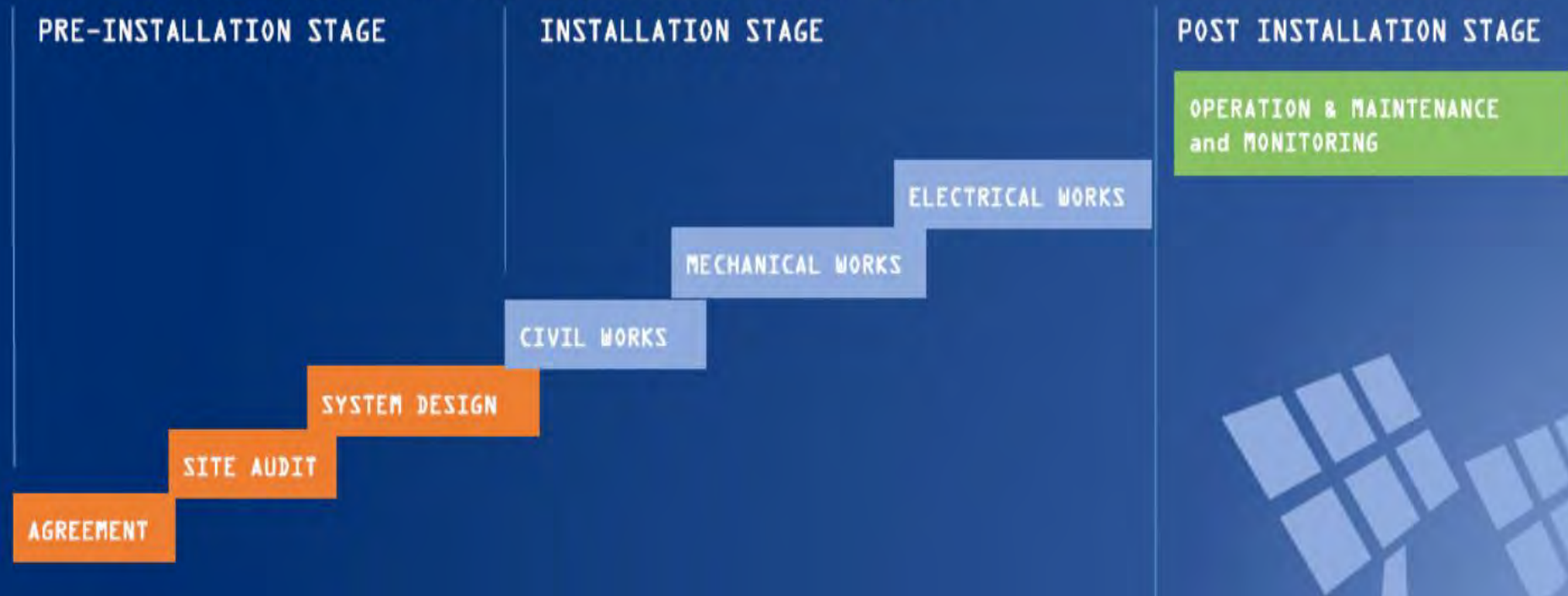

PROJECTS COMPLETED



- In rooftops, also we have established ourselves as experts with installation of solar rooftop systems on Asbestos Sheet, Industrial Roofs and on the roofs of PEB Structures along with regular installation on RCC Roofs!
- We are the only company to have installed on the live hangers on Airports.
- We have successfully delivered two key project in GCC one being 10 MW ground mounted project which was executed for Sterling & Wilson:
 - In UAE, for Abu Dhabi's prestigious Noor Abu Dhabi Solar Park, &
 - In Qatar for an industrial client.

PROJECTS COMPLETED



- In rooftops, also we have established ourselves as experts with installation of solar rooftop systems on Asbestos Sheet, Industrial Roofs and on the roofs of PEB Structures along with regular installation on RCC Roofs!
- We are the only company to have installed on the live hangers on Airports.
- We have successfully delivered two key project in GCC one being 10 MW ground mounted project which was executed for Sterling & Wilson:
 - In UAE, for Abu Dhabi's prestigious Noor Abu Dhabi Solar Park, &
 - In Qatar for an industrial client.

Details - To Inform & Discuss with Clients!

1) For your information:

- a) For 8 hours to 12 Hours of running, the Formula will be "Total Consumption Per Month in KW / 31 Days / 4 Units".
- b) For 13 hours to 24 Hours of running, the Formula will be "Total Consumption Per Month in KW / 31 Days / 3 Units".

2) What to inquire from the Client?

- a) What is Total Electricity Consumption (in KW) per month?
- b) For example, if the Client replies 50,000KW as its Total Electricity Consumption Per Month for 8 hours to 12 hours running of Machines or Factory; then, $50,000 / 31 / 4 = 403.23\text{KW}$ per month.
- c) For example, if the Client replies 50,000KW as its Total Electricity Consumption Per Month for 13 hours to 24 hours running of machines or Factory, then, $50,000 / 31 / 3 = 537.63\text{KW}$ per month.

3) Equipment Details:

- a) 100% Non-Chinese Equipment will be used for the Solar Project.
- b) All Solar Panels pertaining to Solar Project will be from Germany & Norway.

4) Installations:

Solar Panels can be installed on any type of Roof or Ground; provided the space by the Client.

Our Services!

1. Within first 5 years' of installation, all the installation costs will be recovered back by the client, and, remaining 20 years' will be Free-of-Cost Electricity to the Client.
2. A Special Software pertaining to the Solar Project will be installed at Client's site, and, the entire Solar Project will be monitored for 24 hours by Supplier's Engineer.
3. An Engineer from Supplier's side will be available 24/7 for any trouble shooting on Solar Project. Will our Eng. Have essential materials to resolve the issue?
4. If there any issue arises in our installed Solar System, the Electricity will automatically switch to Government's Electrical Grids to avoid any operation interruption until the problem is resolved & the Solar System is back to normal.
5. In case of any issue due to bad whether, clouds, sand storm, rain, etc.; we will take care of maintenance on agreed cost between both the parties.
6. While visiting client, we give location, space, photo of the site via Google on WhatsApp to our team in India. Within 2 hours, the client will receive tentative cost of total installation (7% to 10% plus or minus)

Our Guarantees!

1. 25 years' Guarantee on all our Solar Panels.
2. 5 years' Guarantee on our Main Panel Board. However, this guarantee is renewable after 5 years' of installation for a period of further 5 years at the cost of SR. 3750.
3. As per the location, we will provide for "Minimum Generation Guarantee" backed by "Bank Guarantee".
4. Our Bank Guarantee will be equivalent to 10% of Generation Guaranteed multiplied by average energy cost of the client, for e.g.; For example if we are guarantying generation of 1,500,000 Units/MWp of installation BG will be equivalent to 150,000* average electricity cost of the end user.

Payment Policies!

1. All payments into the account of AMAZIY LLC or AMAZIY Petro Trading LLC SOC and must be done via Letter of Credit (Irrevocable, Transferable, Revolving & Divisible LC MT 700 payable monthly via MT 103).
2. 10% Advance at the time of signing main contract.
3. 50% before dispatch of Modules from our Warehouse.
4. 10% before dispatch of Inverters from Manufacturers'/Suppliers' Warehouses.
5. 20 % at receipt of BOS at site.
6. 10% on successful commissioning of the project.
7. According to above, payments for different vendors will be made by us to different suppliers across the globe
8. All original invoices of all the vendors will be shared to us by the main suppliers

Our Awards!



AMAZIY COSMETICS

Our Products



Kindly visit the site <https://amazy.com/shop/> to view our more than 50 Products

AMAZIY ENGINEERING

Introduction



AMAZIY Engineering, a sister company of **AMAZIY Group of Companies**, is a Jeddah-based electro-mechanical contractor specializing in mission-critical, 24/7 facilities built for zero-downtime industries. With 12 years of experience, we specialize in delivering GACA-compliant electrical, mechanical, HVAC, and O&M solutions for transportation and high-security infrastructure with a Mission to ensure 100% uptime of critical airport systems while meeting GACA, ICAO, and NFPA safety standards.

Our enthusiastic teams of professionals are driven by a passion for customer satisfaction and we go the extra mile to ensure seamless transactions with on-time deliveries ensuring competitive pricing in parallel! Irrespective of a large-scale operation or a small business entity, we cater clients of all sizes with equal dedication, loyalty and respect as we firmly believe that our success is knotted with the success of our clients!! Therefore, we place our highest emphasis on building long-lasting relationships based on trust, transparency and reliability!

We look forward to partnering with you and delivering our exceptional on-time services to steer positively your growth and prosperity. So, together, let's build a better future.

Core Departments

Department	Key Divisions/ Functions	Main Responsibilities
1. Projects & Engineering	Tendering/Estimation	RFQ analysis, costing, BOQ, bid submission
	Design & Engineering	SLD, load calculations, HVAC/plumbing design, shop drawings, as-builts
	Project Management	Planning, scheduling, site execution, client coordination
	QA/QC	ITP, material inspection, testing & commissioning, SEC/GACA compliance
2. Operations & Maintenance	AMC Division	Preventive maintenance, SLA management, KPI reporting
	Emergency Response Team	24/7 break down crew, <2hr mobilization, rapid repairs
	Service Division	Small works, repairs, call-out jobs
	Reliability/Energy	Thermography, vibration analysis, energy audits, NEEP compliance
3. Construction/Site	Electrical Division	Cable laying, panels, AGL, lighting, VFDs, generators, ATS
	Mechanical Division	Piping, pumps, chillers, boilers, HVAC, welding, fabrication
	Civil/Support	Foundations, trenching, duct banks, minor civil works
	Testing & Commissioning	Megger, HI POT, TAB, BMS/SCADA integration, handover docs

Business Support Departments

Department	Key Divisions/Functions	Main Responsibilities
4. Business Development	BD & Sales	Vendor registration, client relations, new markets like NAQUA/JEDCO
	Proposals	Technical + commercial proposals, presentations, pre-qual docs
	Marketing	Company profile, website, branding, case studies
5. Procurement & Logistics	Procurement	Vendor sourcing, PO issuance, material submittals, approvals
	Warehouse/Logistics	Material receiving, inventory, site delivery, critical spares stocking
	Contracts	Sub-contractor agreements, back-to-back terms, claims
6. Finance & Accounts	Finance	Budgeting, cash flow, bank guarantees, project costing
	Accounts	Invoicing, AR/AP, payroll, VAT filing, ZATCA compliance
	Audit	Internal controls, external audit coordination
7. HR & Administration	Human Resources	Recruitment, Saudization, iqama/visa, payroll, training
	Admin	PRO, office management, insurance, vehicle fleet
	Training	Technical upskilling, safety, GACA/airside induction
8. HSE & Quality	HSE	Site safety, PTW, incident investigation, FOD/airside safety
	Quality	ISO 9001/14001/45001 docs, NCR, audits, customer satisfaction
	Compliance	SEC, MMRAH, GACA, Civil Defense, local authority approvals
9. IT & Systems	IT Support	Email, servers, ERP, cybersecurity, user support
	BMS/SCADA Team	Software support, programming, integration for client sites
	Document Control	Drawing register, submittal tracking, digital archive, transmittals

Executive Team

Department	Roles	Main Responsibilities
10. Executive Management	General Manager/CEO	Overall strategy, P&L, key client relations
	Operations Director	Project delivery, O&M performance, resource planning
	Technical Director	Engineering standards, value engineering, technical approvals
	Finance Director	Financial control, risk, banking, commercial strategy

Manpower

TRADE	Number Of Employees	TRADE	Number Of Employees
Mangerment Level	13	Steel Fixer	15
QA/QC Engineer	3	Welder	4
Civil Engineer	3	Plumber/Pipe Fitter	12
Electrical Engineers	4	Driver (HV)	4
Mechanical Engineers	4	Driver (LV)	3
instrumentation engineer	3	Operator - Heavy Equipmen	5
Safety Supervisor	3	Mason	10
Site Engineers	6	Tile Setter	8
Supervisor	7	Skilled Helper	48
Surveyor	4		
Foreman	7		
Mechanical Fitter	10		
Mechanical Technician	15		
Electrical Technician	20		
Store Keeper	5		

Equipment



amazy
GROUP OF COMPANIES

Description	Nos	Description	Nos
Excavator	5	Pickup truck 4x4	12
Bulldozer	2	Plate Compactor	8
Boom Truck	4	Jumper Compactor	5
JCB	5	Generators (220 Kw)	7
Bobcat	4	Generators (115 Kw)	7
Loader	5	Vibrator	12
Truck	7	Welding Set 400 AMS	15
Trailer	5	Crew cab Pickup	6
Water tanker	4	Complete Carpenter Power Tool shop	12
Coaster (25 Passengers)	4	Leica Total Station	5
Jeep 4X4	4	Theodolite	4
Dyna 12 Seaters	5	Auto Level instrument	7

Services Aligned With JEDCO/KAIA Operations

Airport Electrical Systems:

1. HV/LV substations, ring main units, and emergency power distribution.
2. UPS, diesel generators, and ATS for ATC, runways, and terminal systems.
3. AGL – Airfield Ground Lighting maintenance & fault finding.
4. BHS – Baggage Handling System electrical controls & motors.
5. SCADA/BMS integration for terminal management.
6. EV charging infrastructure for airport fleet.

Airport Mechanical & HVAC Systems:

1. Chillers, cooling towers, AHUs, and FCUs for terminals.
2. Ventilation & smoke extraction for tunnels and concourses
3. Potable water, firefighting pumps, and plumbing systems.
4. Diesel engine maintenance for emergency generators.
5. Plumbing & drainage for terminals, cargo, and admin buildings.

Operations & Maintenance for Airports:

1. AMC Contracts: SLA-based maintenance for HVAC, electrical, and fire systems.
2. 24/7 Emergency Response: Jeddah HQ, <30min mobilization to KAIA terminals.
3. Airside Compliance: Badged staff trained for airside safety, FOD, and ramp procedures.
4. Energy Management: Audits to reduce KAIA's utility costs under NEEP.
5. Critical Spares: Local stock of chiller parts, motors, breakers for immediate replacement.

Emergency For JEDCO/KAIA OPERATIONS Team

- * **Emergency Response Team** – <30min to KAIA.
- * **Compliance** – QA/QC – GACA, SEC, NFPA.
- * **HSE** – Airside safety, confined space, LOTO.
- * **AMC Division** – SLA-based with 98%+ uptime KPIs.
- * **Engineering** – In-house design to value-engineer solutions.

Why Should We Approved

JEDCO/KAIA Priority	Our Advantage
Passenger Safety & Uptime	24/7 hotline [+966 XX XXX XXXX]. NFPA 70E + GACA safety trained staff
GACA Compliance	Experience with aviation standards. Staff ready for KAIA security badging
HVAC for Terminals	[X] executed projects for malls, hospitals, high-occupancy buildings
Emergency Power	SEC-licensed team. DG-UPS-Solar sync, black-start testing expertise
Local to KAIA	Jeddah-based HQ & warehouse. 15km from terminals vs Riyadh/Dammam firms
Saudization	[X]% Saudi engineers & technicians. MHRSD certificate attached

Relevant Project Experience

Scope	JEDCO Relevance
3x 1000TR chillers, BMS, 11kV substation	Terminal cooling, high-reliability
Full HVAC, generators, fire pumps for 300-bed hospital	Life safety, 24/7 uptime
SCADA/BMS for 50,000m ² facility	Terminal management systems
2N UPS + 2MW DG, Tier-III design	ATC/data center redundancy

Certifications & Compliance For Aviation Work

- ✓ **Licenses:** SEC Approved Electrical Contractor | MMRAH.
- ✓ **Management Systems:** ISO 9001:2015, ISO 14001:2015, ISO 45001:2018.
- ✓ **Compliance:** ZATCA VAT Cert, Chamber of Commerce, Saudization Cert – MHRSD.
- ✓ **Safety:** Staff with airside safety training. Ready for KAIA badge process.
- ✓ **Financials:** Bank reference from [Bank Name]. 3-year audited statements available.

Hse & Airport-specific Safety

- We operate under a zero-incident policy compliant with GACA Part 139 and ICAO Annex 14.
- Our HSE manual includes FOD prevention, airside driving, LOTO for electrical systems, and hot work permits.
- All technicians undergo airport safety induction before deployment.

AIR DISTRIBUTION – SYSTEMS & PRODUCTS

Manufacturing













We are specialized in manufacturing central air conditioning ducts and accessories with expertise in equipment (Plasma Cutter Machine and Auto Line Machine), and notable projects primarily associated with King Abdulaziz University (KAU) and other institutions. The projects include rehabilitation and construction of various buildings, classrooms, sports facilities, and research centers while emphasizing our core focus on quality production!

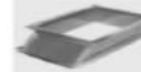

Rectangular Ducts

Material Construction:

- ✓ Stainless Steel.
- ✓ Mild Steel.
- ✓ Aluminum.

<ul style="list-style-type: none"> Straight Duct  Straight Duct-SD Straight Double Wall Duct  <ul style="list-style-type: none"> • Solid Inner Shell With Thermal Insulation-DWD • Perforated Inner Shell-DWPD Straight Lined Duct  Straight Lined-SLD Split Bend  Split Bend-SB Cross Fitting  Cross Fitting-CF Y Branch  Wye-Branch - WYEBS Reducer  <ul style="list-style-type: none"> • Concentric Reducer-CRED • Eccentric Reducer-ERED Elbow  <ul style="list-style-type: none"> • Rectangular Radius Bend-RE • Radius Elbow With Splitter Vanes-REV • Transitional Elbow-TE • Square Throat Bend -SQEV 	<ul style="list-style-type: none"> Take Off 450  Take Off 45° to 4 Turning Vanes  <ul style="list-style-type: none"> • Turning Vanes • Splitters vanes Offset  <ul style="list-style-type: none"> • Offset - OFF • Radius Offset Rectangular Tee  Rectangular Tee Rectangular To Round  Transition Duct - <p>Material of Construction</p> <p>Method of Construction</p> <p>Rectangular Duct Specificat</p> <ul style="list-style-type: none"> • Transverse Joints • Corner Assembly • Assembly Sequence • Duct Work Construction Sch • Duct Factory Shop Standard
---	--

Method of Construction

Longitudinal

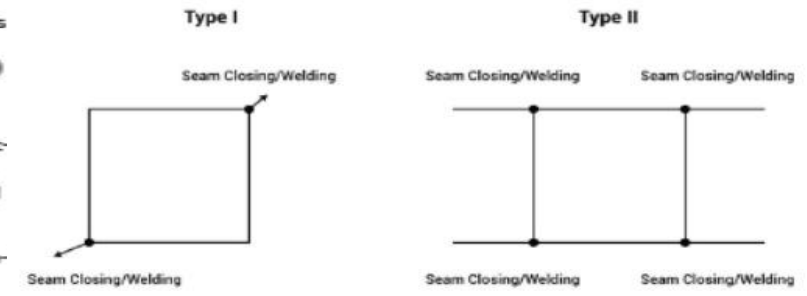

Transverse Joints

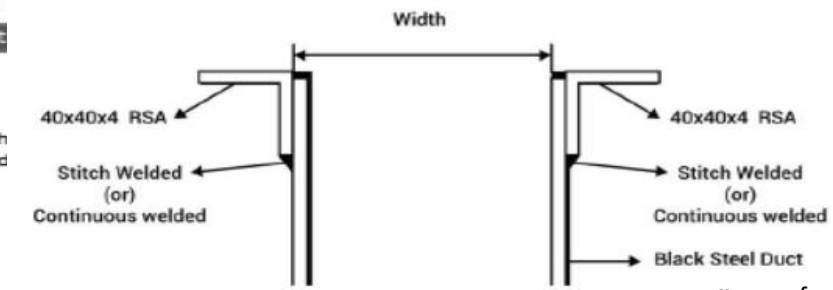

Plenums (Boxes)

TYPE- LP
W-Width-mm
H- Height-mm

Linear Plenum Boxes



Liner Plenum-LP

Dimension

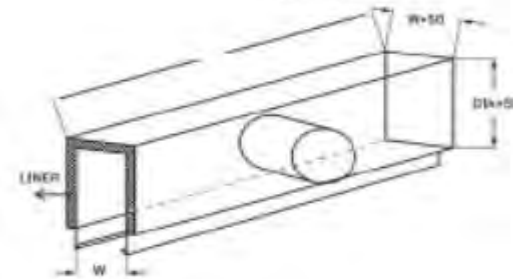
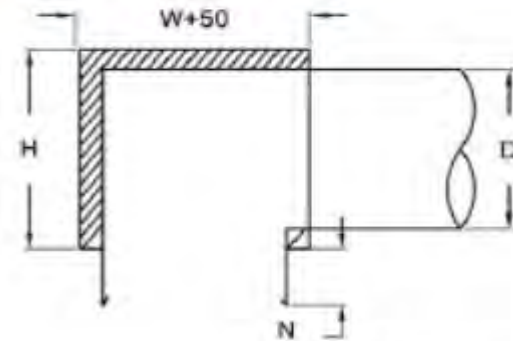

Square Plenum Boxes

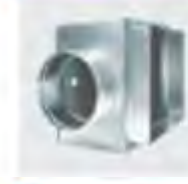

Square Plenum Box - SPB

Dimension

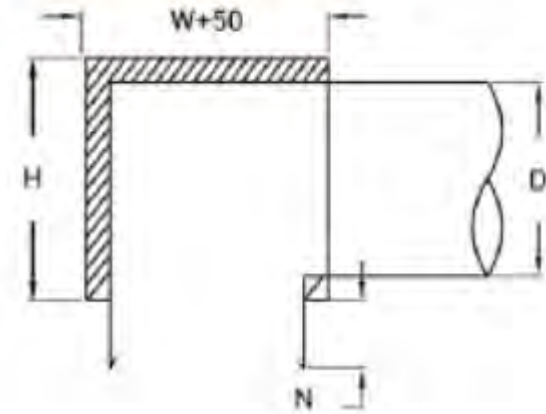

Volume Control Dampers

Product Code: VD-XX-AA-W-H

- XX Type A : T.D.C
 Type B : S&D
 Type C : Slide on Flange
 Type D : Angle Frame
- AA OPB : Opposed Blade
 PB : Parallels Blade

W= Width
 H= Height

Volume Control Damper

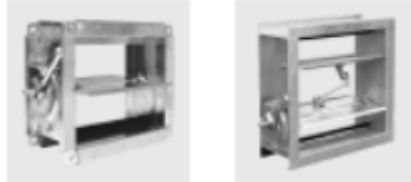

Discription

The design of Volume Control Dampers is intended to ensure effortless operation while upholding secure and seamless airflow and distribution, aiming to attain the utmost level of comfort.

Material Specification

SIZE in mm	GAUGE	
	Blade	Frame
From 100 to 1000	18G	18G
From 1001 to 2000	18G	16G
2001 & above	16G	16G

(Round Damper(VCD))



Discription

Round Dampers are designed to suit the easiest operation with maintaining safe and smooth air flow and distribution to achieve the maximum comfort level.

SPECIFICATION

SIZE in mm	Quadrant Details	GAUGE	
		Blade	Frame
From 100 to 200		20G	22G
From 201 to 250	KS-195	20G	22G
From 251 to 400	KL-7R	20G	22G
401 & Above	KL-7R	18G	20G

Flexible Duct Connectors

Flexible Duct Connector

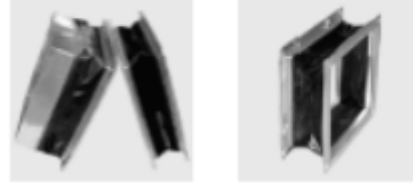

Discription

Applied in industrial and commercial settings, Flexible Duct Connectors serve to eradicate noise and vibration in duct systems. Their primary function involves isolating vibration and noise at the point of origin, achieved through an airtight, fabric-to-steel joint on both sides. This connector is positioned between mechanical equipment or moving components, effectively mitigating the transmission of noise and vibration. Different fabric types, cloth widths, and metal widths can be selected to match specific job needs or the particular application's characteristics.

CONSTRUCTION

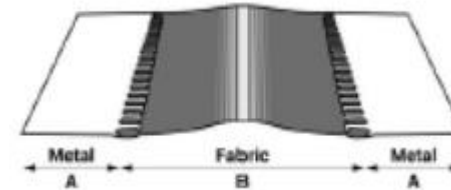
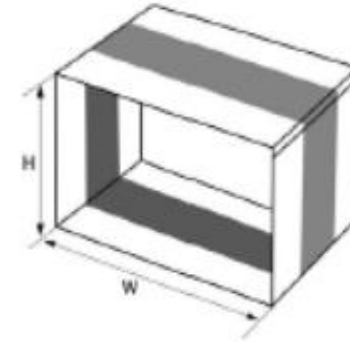

Guard Lock Seam

FDCJ-1.75" X 3" X 1.75"-WXH

FDCE-2.75" X 4" X 2.75"-WXH

Type-FDCJ/FDCE

Size-Metal x Fabric x Metal

Metal-Galvanized

W- Width mm

H-Height mm

Duct Access Doors

Type-ADC
W-Width-mm
H- Height-mm

Access Door with Camlock



ADC

Discription

ADC model shall be camlocks on both end, the selection is ideal where sufficient clearance is not available for door movement, can be easily dismanteled from the frame easily.

Access Door with Hinges



ADHC

Discription

ADHC model shall be with hinges on one end and the camlock on other end, the selection Shall be as per the available clearance require to open the door. Otherwise select the ADHC model if sufficient clearance is not available

Dimension

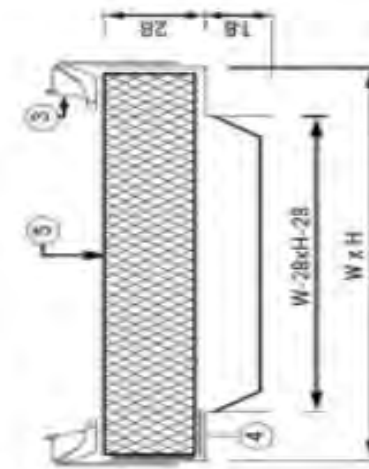
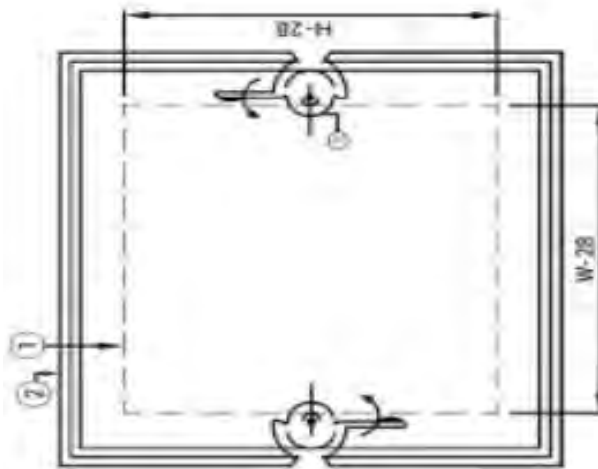

1. Door Panel
2. Frame
3. Self tightening camlocks
4. Gasget
5. Mineral wool insulation

Sound Attenuators

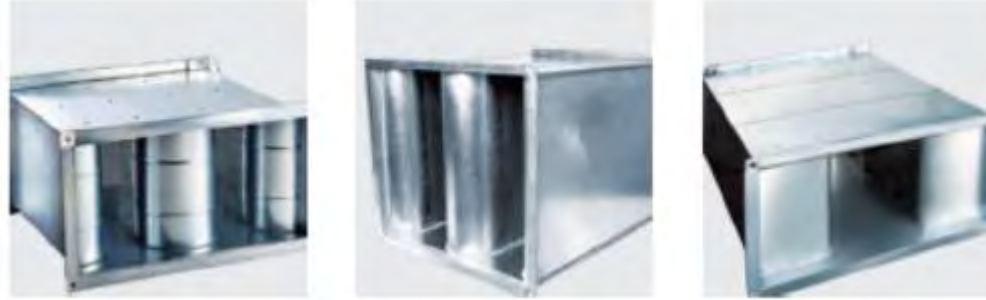

OPTIONAL FEATURES

Model	Standard Width
ESAP	Mutiple of 300 mm

NOISE CONTROL FOR HVAC SYSTEMS

Effective acoustical design necessitates balanced collaboration across architecture, structural, mechanical, electrical engineering, and acoustic fields. Postponing acoustical design until after finalizing the structural system design can limit the design team's options for choosing and placing affordable noise control equipment and accessories.

Attaining HVAC noise standards requires addressing various sound sources and pathways. Follow specific procedures to achieve desired noise levels and recommended criteria.

Discription

Ordering Product Code:
ESA - A - W- H- L

STL - Type
SA - Sound Attenuator
A - Type
W - Width
H - Height
L - Length

- Both Horizontal & Vertical construction are Available
- Upon request TDC, S&D, side on Flange connector type are also available

Air Field Lightings

Taxiway



AL-105-02-BL

Approach



AL-101-03-WH

RTIL



PAPI/APAPI



AL 088-30-WH-RE

Runway Edge



AL-103-06-WH

Threshold/End



AL-104-04-GR/RE

Location and Runway hold position



Windcone



AL-081-XX

Runway Guard Light



Direction



AL 087-02-WH-RE

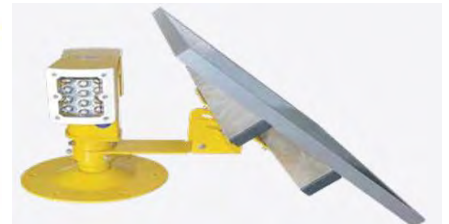

AL-071-04-WH



AL-073-03-GR



AL-089-03-WH - ALIG



AL-072-03-BL



AL-117-48-GR/RE



AL-074-18-WH



AL 088-30-WH-RE



AL-010-02-BL



AL-056-08-WH



AL-061-84-WH



AL-122-03-YE



AL-121-04-GR



AL-120-05-GR



AL-122-03-GR



AL-123-06-GR

Battery Chargers



Charging Rack



Individual Charger



Solar Power

Live Pics of Our Completed Sites



ELECTRO – MECHANICAL PROJECTS

Electro-Mechanical Projects Completed (1)

S. NO.	PROJECT	YEAR
1	Process instruments calibration and testing contract	2002
2	Design, Supply and installation of temperature control, monitoring and recording system at main drug storage warehouse	2002
3	Annual contract of process line instrumentation and control system calibration and testing	2004
4	Plant maintenance and operation contract including Furnace control and monitoring system	2004
5	Cold Storage Installation at SITcO Pharma Riyadh	2005
6	Cold Storage Installation at Al Safi Milk Factory Al Kharj	2005
7	Supply and installation of fuel flowmeters for gas turbine units	2006
8	Plant calibration and loop testing for gas turbine power generation system	2006
9	Process control and monitoring system modification and Integration of clinker plant	2006
10	Installation, Calibration and loop testing of complete process instrumentation and automation for gas turbine units	2008
11	Formation and installation of Tank Management System for fuel storage tanks	2007-08
12	Supply, Installation and connection with main SCADA of Fuel Tank Level Transmitters	2008
13	Installation of Temperature Control system with VFD driven cooling towers for RO plant	2008
14	Saudi Air Line cargo building, Installation of BMS	2009
15	Installation of surveillance poles and motion detectors	2009
16	Construction of MPP stage 1 project. Line monitoring and control instruments to communicate with MCR	2009
17	Construction of Scaffolding Factory	2010
18	Construction of Saudi Air Line Cargo Office Building	2011

Electro-Mechanical Projects Completed (2)

S. NO.	PROJECT	YEAR
19	Cooling Systems for wet scrubbers	2011
20	Installation, Commissioning of RO plant at King Abdullah Economic City	2011
21	Replacement of fuel supply system boilers phase 2 at SWCC along with complete control system	2011-13
22	Construction of water supply system from RO to substation with control system and instrumentation	2012-13
23	Civil works Institute of public Administration Housing building	2012
24	Concrete & Reinforcement of 380kV OHTL Jeddah	2013
25	Construction of OWT1 and OWT2 surge protection station of Yanbu Madinah water transmission system	2013
26	Construction of oxygen tank. Control and monitoring system and instrumentation at Abdullah Hashim Plant	2014
27	Supply and installation of CO2 plant and control system with evaporator and condensation system and automation	2014
28	Upgrade of PLC system for boilers at SWCC main plant	2014
29	Ministry of Défense Wireless 100 Meter Tower	2016
30	Saudi Aramco Surveillance pole civil	2016
31	Concrete & Reinforcement of 132kV OHTL from Muhayil ~ Shabian	2016
32	Concrete & Reinforcement of 380kV OHTL from Rabigh ~ Makkah	2016
33	Installation and commissioning of instrument and control system at main crusher on MBCC Site	2017-18
34	Supply and installation of process line for packing and control system for Al Reef Sugar Refinery	2016-18
35	Water Terminal Station at YMWTS	2018
36	Field instruments testing, overhauling and repair. Calibration of control system at LUBRAF	2018

Electro-Mechanical Projects Completed (3)

S. NO.	PROJECT	YEAR
37	Installation and commissioning of domestic water meters and connection to main distribution line	2018-19
38	Testing, Calibration and verification of Flowmeters at 1400mm water line at Taif water distribution system	2018
39	Construction of control and monitoring system at oil refining plant of a private group	2018-19
40	Fuel off load and treat maintenance facility (JETTY). Upgrading of complete instrumentation, control system and operation structure	2018-19
41	Installation and commissioning of instrument and control system at main crusher on MBCC Site	2017-18
42	Concrete & Reinforcement of 132kV OHTL from Muhayil ~ Bariq	2019
43	Construction of MPP Stage-1 Project in Global Company for Chemical industries	2019
44	Concrete & Reinforcement of 132kV OHTL from Madina East Substation to Airport	2020
45	Construction of Extension of Receiver & launcher area in SWCC	2020
46	CIVIL WORK REPAIRS V.730292 REPLACEMENT OF 32NOS. SLUICE GATES MARAFIQ JUBAIL SITE	2020
47	Instrumentation verification, calibration and loop testing project at SWCC Plant	2021
48	Supply, Installation and commissioning of TMS and control system for process line at IFFCO	2021
49	Annual contract of process line instrumentation and control system calibration and testing of TETRA Pack	2022
50	Supply and installation of different fuel supply network Middle East Paper	2023
51	Replacement of instrument panels	2023
52	Supplying of Precast Foundation for MVPS in Shoiba	2023
53	Installation of CEMS system on Turbine exhaust system SEC MADINAH	On-going
54	Supplying of Precast Foundation for MVPS in Shoiba	On-going
55	Supply and installation of Plant ventilation system	On-going
56	HVAC installation Project at Al Rayes Water Treatment Plant with Al Khorayef Group	On-going

Live Pics of Our Completed Sites



Live Pics of Our Completed Sites



Live Pics of Our Completed Sites



Live Pics of Our Completed Sites



Live Pics of Our Completed Sites



Live Pics of Our Completed Sites



Live Pics of Our Completed Sites



Live Pics of Our Completed Sites



AMAZIY CONSTRUCTION

Construction Projects Completed – 2013

Medical Area Renovation works 2013

Project Duration : 6 Months Project status : Completed

Name of Project : Medical Area Renovation works

Project Description :

Supply & Installation of Fcu,s , Chilled Water piping,
Duct works with all accessories.

SR 429,000.00

Prince Sultan Palace Makkah 2013

Project Duration : 6 Months Project status : Completed

Name of Project : Princess Villa.

Project Description :

PACU,s Installation, Duct works with all accessories.

SR 618,000.00

Jameel Saeed Ammar Company 2013

Project Duration : 6 Months Project status : Completed

Name of Project : Toy Land Alia MaalMadina.

Project Description :

Equipment Installation, Controls, Duct works with
all accessories.

SR 912,000.00

Construction Projects Completed – 2014



Jameel Saeed Ammar Company

2014

Project Duration : 4 Months Project status : Completed
 Name of Project : Toy Land Al Dana Mall Yanbu.
 Project Description :
 Equipment Installation, Duct works with all accessories, Controls
 SR 736,000.00

Jameel Saeed Ammar Company

2014

Project Duration : 6 Months Project status : Completed
 Name of Project : Toy Land Al Dana Mall Yanbu
 Project Description :
 Equipment Installation, Duct works with all accessories, Controls
 SR 736,000.00

Royal Commission Yanbu

2014

Project Duration : 6 Months Project status : Completed
 Name of Project : Homodylasis Area
 Project Description :
 PACU,s Installation, Controls, Duct works with all accessories.
 SR 397,000.00

Royal Commission Yanbu

2014

Project Duration : 3 Months Project status : Completed
 Name of Project : ICU Expansion Area.
 Project Description :
 PACU,s Installation, Controls, Duct works with all accessories
 SR 254,000.00

Royal Commission Yanbu

2014

Project Duration : 6 Months Project status : Completed
 Name of Project : Homodylasis Area
 Project Description :
 PACU,s Installation, Controls, Duct works with all accessories
 SR 397,000.00

Royal Commission Yanbu

2014

Project Duration : 2 Years Project status : Completed
 Name of Project : TWomen Campus University
 Project Description :
 : Installation of AHU,FCU,Exhaust Fans, Chilled Water Piping , Duct works with all accessories
 SR 1,359,000.00

Construction Projects Completed – 2015

King Abdul Aziz University Jeddah 2015	King Abdulaziz University 2015
Project Duration : 1 Years Project status : Completed Name of Project : 2.600 Central Kitchen Kaau Project Description : Propeller Fans, Hoods, Black Steel Duct, VAVs, FCU,s Chilled Water Piping ,Duct works with all accessories SR 847,000.00	Project Duration : 11 Months Project status : Completed Name of Project : Central workshop and Labs(CN:4600) Project Description : PSupply & Installation of all HVAC works. SR 1,526,000.00
Smart Offices –Jameel Square Jeddah 2015	King Abdulaziz University 2015
Project Duration : 7 Months Project status : Completed Name of Project : Project Solutions Group Australia Project Description : , FCUs, Chilled Water Piping, Exhaust fans,Duct works with all accessories SR 984,000.00	Project Duration : 3 Months Project status : Completed Name of Project : Vip booth Project Description : Supply & Installation of Chilled Water Pre-Insulated underground pipes SR 320,000.00
Riyadh Bank Sharaya Makkah 2015	King Abdulaziz University 2015
Project Duration : 4 Months Project status : Completed Name of Project : Modern Horizon Contracting co. Project Description : PACU,s Installation, Duct works with all accessories SR 149,000.00	Project Duration : 3 Months Project status : Completed Name of Project : EngeneeringBuildiing- KAAU – Jeddah. Project Description : Supply & Installation of Chilled Water Pre-Insulated underground pipes SR 2,841,000.00

Construction Projects Completed – 2016

Al Zahi Contracting co 2016

Project Duration : 3 Months Project status : Completed

Name of Project : Girls Class rooms- KAAU Jeddah

Project Description :

Duct works with all accessories.

SR 2,746,000.00

Al Amoudi Contracting Est 2016

Project Duration : 3 Months Project status : Completed

Name of Project : Vise Presidency Building- KAAU Jeddah

Project Description :

Complete HVAC With BMS System.

SR 2,154,000.00

King Abdul Aziz University –Jeddah 2016

Project Duration : 7 Months Project status : Completed

Name of Project : Female Housing Project

Project Description :

Complete HVAC Works.

SR 3,457,600.00

Construction Projects Completed – 2017

King Abdul Aziz University –Jeddah 2017

Project Duration : 5 Months Project status : Completed
 Name of Project : MMC Building – KAAU Jeddah.
 Project Description :
 Complete HVAC Works With Equipment's
 SR 3,258,000.00

King Abdul Aziz University –Jeddah 2017

Project Duration : 3 Months Project status : Completed
 Name of Project : KFMRC Building – KAAU Jeddah
 Project Description :
 Complete HVAC Works With Equipment's.
 SR 1,476,000.00

Construction Projects Completed – 2018



King Abdul Aziz University –Jeddah 2018

Project Duration : 3 Months Project status : Completed
 Name of Project : Girls Driving School – KAAU Jeddah
 Project Description :
 Complete Electro-Mechanical Works With BMS System
 SR 5,738,000.00

King Abdul Aziz University –Jeddah 2018

Project Duration : 6 Months Project status : Inprogress
 Name of Project : Building -71.
 Project Description :
 Complete HVAC Works.
 SR 960,000.00

King Abdul Aziz University- KAAU Jeddah. 2018

Project Duration : 15 Months Project status : Inprogress
 Name of Project : Switch Gear Room.
 Project Description :
 Complete Mechanical Works.
 SR 3,547,000.00

King Abdul Aziz University- KAAU Jeddah 2018

Project Duration : 9 Months Project status : Inprogress
 Name of Project : Building -107
 Project Description :
 Complete HVAC Works.
 SR 1,600,000.00

King Abdul Aziz University –Jeddah 2018

Project Duration : 1 Months Project status : Completed
 Name of Project : Nursery School – KAAU Jeddah.
 Project Description :
 Complete HVAC Works with Equipment's
 SR 401,000.00

King Abdul Aziz University- KAAU Jeddah 2018

Project Duration : 6 Months Project status : Inprogress
 Name of Project : Building -46
 Project Description :
 Complete HVAC Works.
 SR 1,105,000.00

SR 1,105,000.00



Live Pics of Our Projects



Live Pics of Our Projects



Live Pics of Our Projects

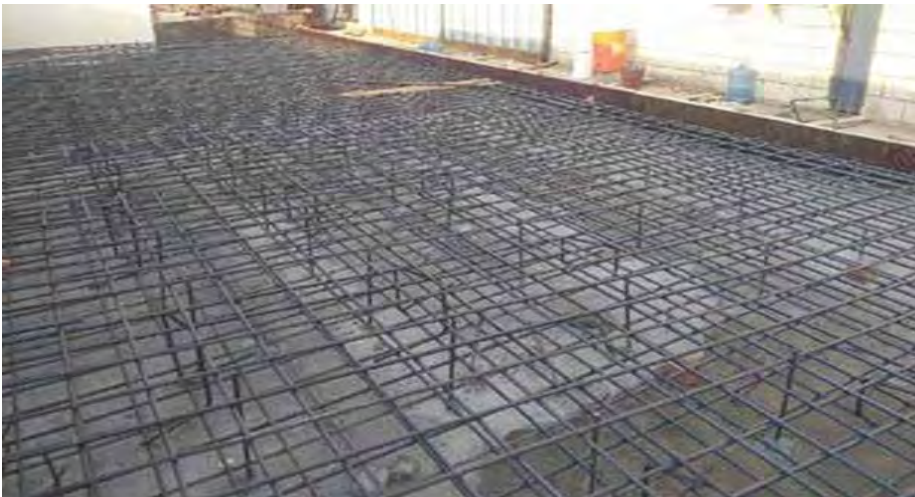

Live Pics of Our Projects



Live Pics of Our Projects



Live Pics of Our Projects



PROJECTS COMPLETED AT KAAU

We have rehabilitated various types of buildings at KAAU such as:

Educational Buildings:

Faculty of Home Economics (Female Building-42A and Building-71).

Economic College and Classroom Building-107 (Female Section).

Classrooms in the Female Section.

Faculty of Economics and Administration (Male).

Administrative Buildings:

Vice Presidency Female Building-51.

Service Building-46 (Female Section).

Sports Facilities:

Sport Stadium.

Sport Tent.

Convention Centers:

Extension of King Faisal Convention Center.

AMAZIY MEDIA WIZ - MARKETING & RESEARCH

Our Marketing Introduction

This is our fully owned International Marketing Services Company in India with a Mission to “positively contribute” into “Saudi economy” by “familiarizing Saudi companies” on “excess” of their “enormous marketing spends”, and, to “guide them conscientiously in optimizing their mega-spends without jeopardizing their key performing indicators (KPIs).

Our Expertise is in Regional Marketing, Media & Corporate Communications, Marketing & Media Research, and, PR Establishment with 17+ years’ proven track record; having worked with Advertising Agencies, MBUs & Blue-Chip Cross-Functional Organizations on ATL, BTL, TTL, Digital & Social Mediums across KSA, GCC & MENACA Regions for FMCG & Non-FMCG Sectors.

Our Core Attributes are Marketing of all types, Marketing & Media Communication, Corporate Communications & PR, Marketing & Media Researches, Marketing & Media Budgeting, Involving with our clients to write good Marketing, Media, Research & Communications’ Briefs., Guiding our clients on identifying Core & Peripheral Targets, Strategic & Tactical Media Planning, Competitive Media Buying, Analytical Media Research, Prolific Media Execution, Conducting Marketing & Media Communications Pitch on behalf of clients, leading as sole point of contact from writing Media Briefs to inviting, perusing, hiring & handling of Media Agency/MBU until constitution of yearly marketing & media contract between our clients & Media Buying Units (MBUs)/Media Agencies, Establishing of Marketing, Media & Research Departments for Saudi Companies.

Our Marketing Achievements

We successfully Launched, Re-Launched and Sustained:

- ✓ 67 FMCG Non-Food; Local & Int'l Brands.
- ✓ 29 FMCG Food; Local & Int'l Brands/Sub-Brands.
- ✓ Successful Category, Product & Brand Activation/Management.
- ✓ Strategic Partnerships with Stakeholders, MBUs, Media Agencies, Media Suppliers (ATL & BTL), Research Agencies & Creative Agencies.

As Strategic & Tactical Media Planning, we directed ATL, BTL, TTL, Digital & Social Media Planning Teams for:

- ✓ 67 FMCG Non-Food; Local & Int'l Brands.
- ✓ 29 FMCG Food; Local & Int'l Brands/Sub-Brands.

As Competitive Media Buying:

- ✓ Distinctively attained SR. 890+ Million Media Buying for 96 Brands/Stakeholders.
- ✓ Proficiently Saved SR. 1.5 Billion on 96 Brands/Stakeholders.
- ✓ All our Stakeholders enjoyed full Added Values, Volume Rebates as Free-of-Cost Campaigns.

We have Direct Association with:

- ✓ 284+ Personnel from Media Agencies/Suppliers.
- ✓ 422+ Mkt. & Media Communication Personnel comprising of various Anchors, Editors-in-Chief,
- ✓ Journalists, Columnists, Reporters, Influencers, Commentators, Cameramen & Videographers.

Our Regional Clients

Oils-Cooking & Frying



Sugars-Fine & Coarse



Ketchup/Vinegars/Sauces



Noodles



Diet Sugars



KSA Government



وزارة التعليم



وزارة الحج والعمرة
MINISTRY OF HAJJ AND UMRAH



SEDA
هيئة تنمية الصادات السعودية
Saudi Export Development Authority

Hypermarket Chains



Milk



Del. App



Our International Clients

Int'l Fast Food Chains



Cars & Water Bikes



Int'l Ice Creams/Chocolates



Airlines



Int'l Education



AC, Elect, Cameras, Binos



Int'l Watches



Int'l Fashions



Our Global Contacts

1. AMAZIY – KINGDOM OF SAUDI ARABIA – admin@amaziy.com
2. AMAZIY – UNITED ARAB EMIRATES – amaziyuae@amaziy.com
3. AMAZIY – GCC – amaziygcc@amaziy.com
4. AMAZIY – MIDDLE EAST – amaziyme@amaziy.com
5. AMAZIY – AFRICA – amaziyaf@amaziy.com
6. AMAZIY – UNITED KINGDOM – amaziyuk@amaziy.com
7. AMAZIY – UNITED STATES OF AMERICA – amaziyusa@amaziy.com
8. AMAZIY – PAKISTAN – amaziyypak@amaziy.com
9. AMAZIY – INDIA – amaziyindia@amaziy.com
10. AMAZIY – GLOBAL – amaziyww@amaziy.com

COMING VERY SOON IN SOUTH AMERICA & FAR EAST.

Thank You😊